



Gates Adapter Global Part Numbering System

Gates adapters feature a meaningful part number that makes coupling identification fast and easy. In the following example, the Global Part Number G60110-0808 identifies a Male Pipe NPTF (MP) to Male Pipe NPTF (MP) adapter with -8 (1/2") pipe thread terminations.

Series Stem Styles:

G60—SAE to SAE **G62**—British to SAE **G63**—Metric Conversion **G64**—International to International **G65**—Japanese Conversion

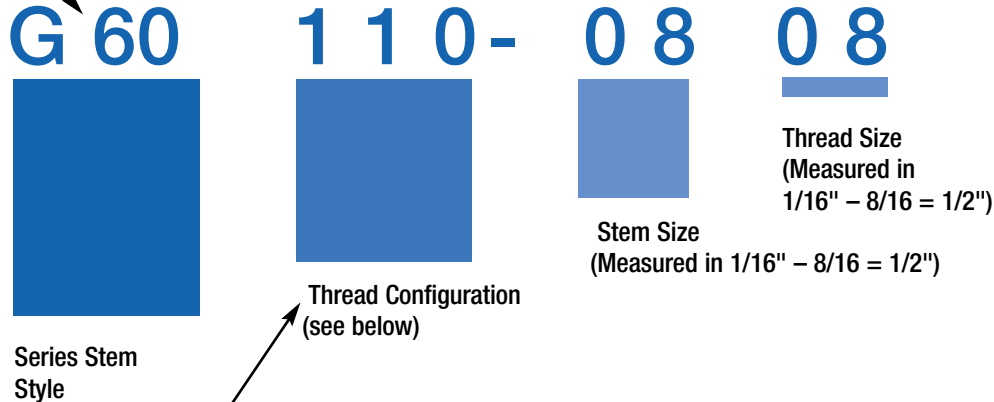

Thread Configurations

These three-digit numbers, along with the series stem style, identify the various coupling thread configurations

SAE to SAE

- 60050**—FFN
- 60051**—FFS
- 60102**—MP-PLUG
- 60110**—MP-MP
- 60115**—MP-MP90
- 60130**—MP-FPS
- 60132**—MP-FPL
- 60136**—MP-FP90
- 60140**—MP-FPX
- 60142**—MP-FPX45
- 60144**—MP-FPX90
- 60152**—FP-FP
- 60156**—FP-FP90
- 60160**—FP-FPX
- 60162**—FP-FPX45
- 60164**—FP-FPX90
- 60181**—FP-FP-FP
- 60183**—FP-FP-MP
- 60184**—FPX-FPX-FPX
- 60186**—FPX-FPX-MP
- 60240**—MZ-MP
- 60248**—OR
- 60240**—MZ-MP
- 60250**—MB-PLUG
- 60275**—MB-FP
- 60285**—MB-FPX
- 60287**—MB-FPX45
- 60289**—MB-FPX90
- 60291**—FB-MP
- 60301**—MB-MJ
- 60308**—MB-MJ45
- 60312**—MB-MJ90
- 60350**—MJ-MJ-MB
- 60352**—MB-MJ-MJ
- 60394**—TS
- 60395**—TSN
- 60399**—LN
- 60401**—FJ-CAP
- 60402**—MJ-PLUG

- Female Flareless Nut
- Female Flareless Sleeve
- Male Pipe NPTF Plug
- Male Pipe NPTF to Male Pipe NPTF
- Male Pipe NPTF to Male Pipe NPTF - 90°
- Male Pipe NPTF to Female Pipe NPTF Reducer Bushing - Short
- Male Pipe NPTF to Female Pipe NPTF Increasing Bushing - Long
- Male Pipe NPTF to Female Pipe NPTF - 90°
- Male Pipe NPTF to Female Pipe Swivel NPSM
- Male Pipe NPTF to Female Pipe Swivel NPSM - 45°
- Male Pipe NPTF to Female Pipe Swivel NPSM - 90°
- Female Pipe NPTF to Female Pipe NPTF
- Female Pipe NPTF to Female Pipe NPTF - 90°
- Female Pipe NPTF to Female Pipe Swivel NPSM
- Female Pipe NPTF to Female Pipe Swivel NPSM - 45°
- Female Pipe NPTF to Female Pipe Swivel NPSM - 90°
- Female Pipe NPTF - Tee
- Female Pipe NPTF on Run to Male Pipe NPTF - Tee
- Female Pipe Swivel NPSM - Tee
- Female Pipe Swivel NPSM on Run to Male Pipe NPTF - Tee
- Male Parker Triple Thread to Male Pipe NPTF
- O-Rings for Straight Thread Boss Fittings
- Male Parker Triple Thread to Male Pipe NPTF
- Male O-Ring Boss Plug
- Male O-Ring Boss to Female Pipe NPTF
- Male O-Ring Boss to Female Pipe Swivel NPTF
- Male O-Ring Boss to Female Pipe Swivel NPTF - 45°
- Male O-Ring Boss to Female Pipe Swivel NPTF - 90°
- Female O-Ring Boss to Male Pipe NPTF
- Male O-Ring Boss to Male JIC 37° Flare
- Male O-Ring Boss to Male JIC 37° Flare - 45°
- Male O-Ring Boss to Male JIC 37° Flare - 90°
- Male JIC 37° Flare on Run to Male O-Ring Boss - Tee
- Male O-Ring Boss to Male JIC 37° Flare to Male JIC 37° Flare - Tee
- Tube Sleeve
- Tube Sleeve Nut
- Locknuts for Bulkhead Fittings
- Female JIC 37° Flare Cap
- Male JIC 37° Flare Plug

- 60405**—MJ-FBO
- 60410**—MJ-MJ
- 60420**—MJ-FJ
- 60422**—MJ-FJX90
- 60424**—MJ-FJX45
- 60445**—MJ-BKHD
- 60446**—MJ-BKHD45
- 60447**—MJ-BKHD90
- 60469**—MJ-MJ-MJ
- 60470**—MJ-MJ-FJX
- 60471**—MJ-MJ-MJBKHD
- 60472**—MJ-MJBKHD-MJ
- 60473**—MJ-FJX-MJ
- 60490**—MJ-MP
- 60497**—MJ-MP45
- 60499**—MJ-MP90
- 60510**—MJ-FP
- 60514**—MJ-FP90
- 60520**—FJX-MP
- 60524**—FJX-MP90
- 60530**—FJX-FP
- 60541**—MJBKHD-MP
- 60551**—MJ-MJ-MP
- 60600**—FPB-CAP
- 60601**—MPB-PLUG
- 60605**—MP-MPB
- 60610**—MP-MPB90
- 60612**—MP-MP-MPB
- 60615**—MP-FPB
- 60620**—MP-FPB90
- 60625**—FI-MP
- 60630**—FI-FP
- 60631**—FP-FPB
- 60632**—FP-FPB
- 60635**—FP-FPB45
- 60637**—FP-FPB90
- 60640**—FP-FP-FPB
- 60641**—FP-MP-FPB
- Male JIC 37° Flare to Female Braze-On
- Male JIC 37° Flare to Male JIC 37° Flare
- Male JIC 37° Flare to Female JIC 37° Flare
- Male JIC 37° Flare to Female JIC 37° Flare Swivel - 90°
- Male JIC 37° Flare to Female JIC 37° Flare Swivel - 45°
- Male JIC 37° Flare to Male JIC 37° Flare Bulkhead
- Male JIC 37° Flare to Male JIC 37° Flare Bulkhead - 45°
- Male JIC 37° Flare to Male JIC 37° Flare Bulkhead - 90°
- Male JIC 37° Flare - Tee
- Male JIC 37° Flare on Run to Female JIC 37° Flare Swivel - Tee
- Male JIC 37° Flare on Run to Male JIC 37° Flare Bulkhead - Tee
- Male JIC 37° Flare to Male JIC 37° Flare Bulkhead to Male JIC 37° Flare - Tee
- Male JIC 37° Flare to Female JIC 37° Flare Swivel to Male JIC 37° Flare - Tee
- Male JIC 37° Flare to Male Pipe NPTF
- Male JIC 37° Flare to Male Pipe NPTF - 45°
- Male JIC 37° Flare to Male Pipe NPTF - 90°
- Male JIC 37° Flare to Female Pipe NPTF
- Male JIC 37° Flare to Female Pipe NPTF - 90°
- Female JIC 37° Flare Swivel to Male Pipe NPTF
- Female JIC 37° Flare Swivel to Male Pipe NPTF - 90°
- Female JIC 37° Flare Swivel to Female Pipe NPTF
- Male JIC 37° Flare Bulkhead to Male Pipe NPTF
- Male JIC 37° Flare on Run to Male Pipe NPTF - Tee
- Female Pipe Cap - Brass
- Male Pipe NPTF Plug - Brass
- Male Pipe NPTF to Male Pipe NPTF - Brass
- Male Pipe NPTF to Male Pipe NPTF - Brass - 90°
- Male Pipe NPTF - Brass - Tee
- Male Pipe NPTF to Female Pipe NPTF - Brass
- Male Pipe NPTF to Female Pipe NPTF - Brass - 90°
- Female Inverted to Male Pipe NPTF - Brass
- Female Inverted to Female Pipe NPTF - Brass
- Female Pipe NPTF to Female Pipe NPTF - Brass
- Female Pipe NPTF to Female Pipe Swivel NPSM - Brass
- Female Pipe NPTF to Female Pipe NPTF - Brass - 45°
- Female Pipe NPTF to Female Pipe NPTF - Brass - 90°
- Female Pipe NPTF - Brass - Tee
- Female Pipe NPTF to Male Pipe NPTF to Female Pipe NPTF - Brass

| |
|------------------------------|
| EQUIPMENT |
| HOSE/CPLG. SELECTION |
| TECH. DATA |
| EXT. & VERY HIGH PRESS. HOSE |
| GS CPLGS. |
| PCM CPLGS. |
| PCS CPLGS. |
| HIGH & MED. PRESS. HOSE |
| MEGACRIMP® CPLGS. |
| PC CPLGS. |
| FIELD ATTACHABLE CPLGS. |
| AIR BRAKE HOSE & CPLGS. |
| MEGATECH®/C5 HOSE & CPLGS. |
| LOW PRESS. HOSE & CPLGS. |
| C14 HOSE & CPLGS. |
| POLARSEAL® HOSE & CPLGS. |
| PWR. STG. HOSE & CPLGS. |
| THERMO-PLASTIC HOSE & CPLGS. |
| ADAPTERS |
| QUICK DISCONNECT CPLGS. |
| ACCESSORIES & ASSORTMENTS |
| PART NUMBER INDEXES |



Thread Configurations — Continued

| |
|------------------------------|
| EQUIPMENT |
| HOSE/CPLG. SELECTION |
| TECH. DATA |
| EXT. & VERY HIGH PRESS. HOSE |
| GS CPLGS. |
| PCM CPLGS. |
| PCS CPLGS. |
| HIGH & MED. PRESS. HOSE |
| MEGACRIMP® CPLGS. |
| PC CPLGS. |
| FIELD ATTACHABLE CPLGS. |
| AIR BRAKE HOSE & CPLGS. |
| MEGATECH™ C5 HOSE & CPLGS. |
| LOW PRESS. HOSE & CPLGS. |
| C14 HOSE & CPLGS. |
| POLARSEAL® HOSE & CPLGS. |
| PWR. STG. HOSE & CPLGS. |
| THERMO-PLASTIC HOSE & CPLGS. |
| ADAPTERS |
| QUICK DISCONNECT CPLGS. |
| ACCESSORIES & ASSORTMENTS |
| PART NUMBER INDEXES |

| | |
|--|--|
| 60642 — FP-FP-MPB | Female Pipe NPTF on Run to Male Pipe NPTF — Brass — Tee |
| 60643 — MS-CAP | Male SAE 45° Flare Cap — Brass |
| 60644 — MS-PLUG | Male SAE 45° Flare Plug — Brass |
| 60645 — MS-MS | Male SAE 45° Flare to Male SAE 45° Flare — Brass |
| 60648 — MS-MS90 | Male SAE 45° Flare to Male SAE 45° Flare — Brass — 90° |
| 60650 — MS-MP | Male SAE 45° Flare to Male Pipe NPTF — Brass |
| 60652 — MS-MP45 | Male SAE 45° Flare to Male Pipe NPTF — Brass — 45° |
| 60654 — MS-MP90 | Male SAE 45° Flare to Male Pipe NPTF — Brass — 90° |
| 60657 — MS-MS-MP | Male SAE 45° Flare on Run to Male Pipe NPTF — Brass |
| 60659 — MP-MS-MS | Male Pipe NPTF to Male SAE45° Flare to Male SAE 45° Flare — Brass |
| 60660 — MS-FP | Male SAE 45° Flare to Female Pipe NPTF — Brass |
| 60664 — MS-FP90 | Male SAE 45° Flare to Female Pipe NPTF — Brass — 90° |
| 60669 — MS-MS-MS | Male SAE 45° Flare — Brass — Tee |
| 60670 — MS-MS-MS | Male SAE 45° Flare — Brass — Tee (Decreasing) |
| 60671 — MS-MS-MS | Male SAE 45° Flare — Brass — Tee (On Run Decreasing) |
| 60680 — MS-CROSS | Male SAE 45° Flare — Brass — Cross |
| 60684 — STS | SAE Tubing Sleeve |
| 60685 — STSN | SAE Tubing Sleeve Nut |
| 60690 — MS-MP-CV | Male SAE 45° Flare to Male Pipe Control Valve — Brass |
| 60691 — MI-PLUG | Male Inverted Plug — Brass |
| 60693 — FI-FI | Female Inverted to Female Inverted — Brass |
| 60698 — ORFF | O-Rings for Flat Face Fittings |
| 60701 — FFOR-CAP | Female Flat-Face O-Ring Cap |
| 60702 — MFFOR-PLUG | Male Flat-Face O-Ring Plug |
| 60724 — MFFOR-MFFOR90 | Male Flat-Face O-Ring to Female Flat-Face Swivel — 90° |
| 60742 — MFFOR-MFFOR-FFORX | Male Flat-Face O-Ring on Run to Female Flat-Face Swivel — Tee |
| 60770 — MFFOR-MP | Male Flat-Face O-Ring to Male Pipe NPTF |
| 60800 — MFFOR-MB | Male Flat-Face O-Ring to Male O-Ring Boss |
| 60801 — MFFOR-MBL | Male Flat-Face O-Ring to Male O-Ring Boss — Long |
| 60805 — MFFOR-MB45 | Male Flat-Face O-Ring to Male O-Ring Boss — 45° |
| 60810 — MFFOR-MB90 | Male Flat-Face O-Ring to Male O-Ring Boss — 90° |
| 60820 — MFFOR-MFFOR-MB | Male Flat-Face O-Ring on Run to Male O-Ring Boss — Tee |
| 60821 — MFFOR-MB-MFFOR | Male Flat-Face O-Ring to Male O-Ring Boss to Male Flat-Face O-Ring — Tee |
| 60880 — FFORX-MJ | Female Flat-Face O-Ring Swivel to Male JIC 37° Flare |
| 60897 — FL-CAP | Code 61 O-Ring Flange Cap |
| 60898 — FLOR | O-Rings for Code 61, Code 62 and Caterpillar-Style Flange Fittings |
| 60899 — CFHS | Flange Half Set (Code 61 — SAE J518) |
| 60900 — FL-MJ | Code 61 O-Ring Flange to Male JIC 37° Flare |
| 60901 — FL4K-MJ/FL5K-MJ | Code 61 O-Ring Flange to Male JIC 37° Flare High Pressure |
| 60905 — FL-MJ45 | Code 61 O-Ring Flange to Male JIC 37° Flare — 45° |
| 60906 — FL4K-MJ45/FL5K-MJ45 | Code 61 O-Ring Flange to Male JIC 37° Flare High Pressure — 45° |
| 60910 — FL-MJ90 | Code 61 O-Ring Flange to Male JIC 37° Flare — 90° |
| 60911 — FL4K-MJ90/FL5K-MJ90 | Code 61 O-Ring Flange to Male JIC 37° Flare High Pressure — 90° |
| 60915 — FL4K-MFFOR/FL5K-MFFOR | Code 61 O-Ring Flange to Male Flat-Face O-Ring High Pressure |
| 60920 — FL4K-MFFOR45/FL5K-MFFOR45 | Code 61 O-Ring Flange to Male Flat-Face O-Ring High Pressure— 45° |
| 60925 — FL4K-MFFOR90/FL5K-MFFOR90 | Code 61 O-Ring Flange to Male Flat-Face O-Ring High Pressure— 90° |
| 60927 — FLH-CAP | Code 62 O-Ring Flange Cap |
| 60929 — FHHS | Flange Half Set (Code 62 — SAE J518) |
| 60930 — FLH6K-MJ | Code 62 O-Ring Flange Heavy to Male JIC 37° Flare (6,000 PSI) |
| 60935 — FLH6K-MJ45 | Code 62 O-Ring Flange Heavy to Male JIC 37° Flare — 45° (6,000 PSI) |
| 60940 — FLH6K-MJ90 | Code 62 O-Ring Flange Heavy to Male JIC 37° Flare — 90° (6,000 PSI) |
| 60945 — FLH4K-MFFOR/FLH6K-MFFOR | Code 62 O-Ring Flange Heavy to Male Flat-Face O-Ring |
| 60950 — FLH4K-MFFOR45/FLH6K-MFFOR45 | Code 62 O-Ring Flange Heavy to Male Flat-Face O-Ring — 45° |
| 60955 — FLH4K-MFFOR90/FLH6K-MFFOR90 | Code 62 O-Ring Flange Heavy to Male Flat-Face O-Ring — 90° |
| 60959 — CATFHS | Caterpillar-Style Flange Halve Sets |

British to SAE

| | |
|---------------------------|---|
| 62150 — MBSPT-MJ | Male British Standard Pipe Tapered Thread to Male JIC 37° Flare |
| 62153 — MBSPT-MJ45 | Male British Standard Pipe Tapered Thread to Male JIC 37° Flare — 45° |
| 62155 — MBSPT-MJ90 | Male British Standard Pipe Tapered Thread to Male JIC 37° Flare — 90° |
| 62200 — MBSPP-MP | Male British Standard Pipe Parallel to Male Pipe NPTF |

| | |
|--------------------------------|--|
| 62220 — MBSPP-FP | Male British Standard Pipe Parallel to Female Pipe NPTF |
| 62300 — MBSPP-MJ | Male British Standard Pipe Parallel to Male JIC 37° Flare |
| 62305 — MBSPP-MJ45 | Male British Standard Pipe Parallel to Male JIC 37° Flare — 45° |
| 62310 — MBSPP-MJ90 | Male British Standard Pipe Parallel to Male JIC 37° Flare — 90° |
| 62320 — MBSPP-FJX | Male British Standard Pipe Parallel to Female JIC 37° Flare Swivel |
| 62450 — MBSPPOR-MJ | Male British Standard Pipe Parallel with O-Ring to Male JIC 37° Flare |
| 62460 — MBSPPOR-MJ90 | Male British Standard Pipe Parallel with O-Ring to Male JIC 37° Flare — 90° |
| 62470 — MBSPPOR-MFFOR | Male British Standard Pipe Parallel with O-Ring to Male Flat-Face O-Ring |
| 62473 — MBSPPOR-MFFOR45 | Male British Standard Pipe Parallel with O-Ring to Male Flat-Face O-Ring — 45° |
| 62475 — MBSPPOR-MFFOR90 | Male British Standard Pipe Parallel with O-Ring to Male Flat-Face O-Ring — 90° |
| 62500 — FBSPP-MP | Female British Standard Pipe Parallel to Male Pipe NPTF |
| 62520 — FBSPP-FP | Female British Standard Pipe Parallel to Female Pipe NPTF |
| 62550 — FBSPP-MJ | Female British Standard Pipe Parallel to Male JIC 37° Flare |
| 62605 — FBSPPX-MP90 | Female British Standard Pipe Parallel Swivel to Male Pipe NPTF — 90° |
| 62650 — FBSPPX-MJ | Female British Standard Pipe Parallel Swivel to Male JIC 37° Flare |
| 62660 — FBSPPX-FJX | Female British Standard Pipe Parallel Swivel to Female JIC 37° Flare Swivel |
| 62801 — FBFOR-MJ | Female British Flat-Face O-Ring to Male JIC 37° Flare |

Metric Conversion

| | |
|--------------------------|---|
| 63099 — MMOR-PLUG | Male Metric O-Ring Plug |
| 63120 — MM-FP | Male Metric with O-Ring to Female Pipe NPTF |
| 63150 — MM-MJ | Male Metric with O-Ring to Male JIC 37° Flare |
| 63160 — MM-MJ90 | Male Metric with O-Ring to Male JIC 37° Flare — 90° |
| 63350 — MDL-MJ | Male DIN 24° Cone — Light Series to Male JIC 37° Flare |
| 63450 — FDLX-MJ | Female DIN 24° Cone Swivel — Light Series to Male JIC 37° Flare |
| 63650 — MDH-MJ | Male DIN 24° Cone — Heavy Series to Male JIC 37° Flare |
| 63750 — FDHX-MJ | Female DIN 24° Cone Swivel — Heavy Series to Male JIC 37° Flare |
| 63980 — MKB-PLUG | Male Kobelco Plug |
| 63990 — MKB-MJ | Male Kobelco to Male JIC 37° Flare |

International to International

| | |
|-----------------------------|---|
| 64075 — BBDS | British Bonded Seal |
| 64094 — MBSPPOR-PLUG | Male British Standard Pipe Parallel with O-Ring Plug |
| 64095 — ORFBSPP | O-Rings for British Standard Parallel Pipe (BSPP Couplings) |
| 64097 — FBSPP-CAP | Female British Standard Pipe Parallel Cap |
| 64098 — MBSPT-PLUG | Male British Standard Pipe Tapered Plug |
| 64099 — MBSPP-PLUG | Male British Standard Pipe Parallel Plug |
| 64350 — MBSPP-FBSPPX | Male British Standard Pipe Parallel to Female British Standard Pipe Parallel Swivel |
| 64775 — MBDS | Metric Bonded Seal |
| 64780 — ORDINL | O-Rings for DIN Light Series (MegaCrimp® and GlobalSpiral™ Couplings) |
| 64781 — ORDINH | O-Rings for DIN Heavy Series (MegaCrimp® and GlobalSpiral™ Couplings) |
| 64782 — ORDIN | O-Rings for DIN Heavy Series (PC, PCM & PCS Couplings) |
| 64787 — BS | Metric Bite Sleeve |
| 64788 — MNL | Metric Bite Nut — Light |
| 64789 — MNH | Metric Bite Nut — Heavy |
| 64790 — MM-PLUG | Male Metric Plug |
| 64792 — MDL-PLUG | Male DIN 24° Cone — Light Series Plug |
| 64793 — FDL-CAP | Female DIN 24° Cone — Light Series Cap |
| 64794 — MDH-PLUG | Male DIN 24° Cone — Heavy Series Plug |
| 64795 — FDH-CAP | Female DIN 24° Cone — Heavy Series Cap |

Japanese Conversion

| | |
|--------------------------|---|
| 65097 — FJIS-CAP | Female Japanese Industrial Standard Cap |
| 65099 — MJIS-PLUG | Male Japanese Industrial Standard Plug/Cap |
| 65100 — FJIS-MJ | Female Japanese Industrial Standard to Male JIC 37° Flare |
| 65597 — FK-CAP | Female Komatsu Cap |
| 65599 — MK-PLUG | Male Komatsu Plug |
| 65600 — FK-MJ | Female Komatsu to Male JIC 37° Flare |
| 65700 — MK-MK | Male Komatsu to Male Komatsu |
| 65750 — MK-MJ | Male Komatsu to Male JIC 37° Flare |
| 65800 — MK-FK90 | Male Komatsu to Female Komatsu — 90° |
| 65950 — MK-FK-MK | Male Komatsu to Female Komatsu to Male Komatsu — Tee |



Adapters — SAE to SAE – G60 Series



For use up to SAE 100R2 maximum working pressure.

SAE to SAE

Male Pipe NPTF Plug

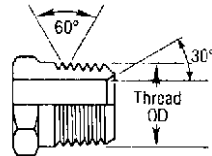

NPTF Solid Male (MP)

| Descr | # | | |  |
|-----------|-------------|-------------|------------|---|
| 2MP-PLUG | 87520 | G60102-0002 | 7253-22815 | 1/8-27 |
| 4MP-PLUG | 87521 | G60102-0004 | 7253-22825 | 1/4-18 |
| 6MP-PLUG | 87522 | G60102-0006 | 7253-22835 | 3/8-18 |
| 8MP-PLUG | 87523 | G60102-0008 | 7253-22845 | 1/2-14 |
| 12MP-PLUG | 87524 | G60102-0012 | 7253-22855 | 3/4-14 |
| 16MP-PLUG | 87525 | G60102-0016 | 7253-22865 | 1-11-1/2 |
| 20MP-PLUG | 87526 | G60102-0020 | 7253-22875 | 1-1/4-11-1/2 |
| 24MP-PLUG | 87527 | G60102-0024 | 7253-24395 | 1-1/2-11-1/2 |
| 32MP-PLUG | G60102-0032 | G60102-0032 | 7253-32765 | 2-11-1/2 |

Male Pipe NPTF to Male Pipe NPTF

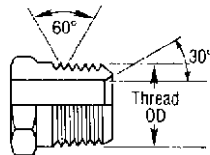

NPTF Solid Male (MP)

| Descr | # | | |  | |
|-----------|-------------|-------------|------------|---|--------------|
| | | | | MP (NPTF) | MP (NPTF) |
| 2MP-2MP | 87420 | G60110-0202 | 7253-23695 | 1/8-27 | 1/8-27 |
| 4MP-2MP | 87421 | G60110-0402 | 7253-23705 | 1/4-18 | 1/8-27 |
| 4MP-4MP | 87422 | G60110-0404 | 7253-23715 | 1/4-18 | 1/4-18 |
| 6MP-4MP | 87423 | G60110-0604 | 7253-23725 | 3/8-18 | 1/4-18 |
| 6MP-6MP | 87424 | G60110-0606 | 7253-23735 | 3/8-18 | 3/8-18 |
| 8MP-4MP | 87425 | G60110-0804 | 7253-23745 | 1/2-14 | 1/4-18 |
| 8MP-6MP | 87426 | G60110-0806 | 7253-23755 | 1/2-14 | 3/8-18 |
| 8MP-8MP | 87427 | G60110-0808 | 7253-23765 | 1/2-14 | 1/2-14 |
| 12MP-8MP | 87428 | G60110-1208 | 7253-23775 | 3/4-14 | 1/2-14 |
| 12MP-12MP | 87429 | G60110-1212 | 7253-23785 | 3/4-14 | 3/4-14 |
| 16MP-12MP | 87430 | G60110-1612 | 7253-23795 | 1-11-1/2 | 3/4-14 |
| 16MP-16MP | 87431 | G60110-1616 | 7253-23805 | 1-11-1/2 | 1-11-1/2 |
| 20MP-20MP | 87432 | G60110-2020 | 7253-23815 | 1-1/4-11-1/2 | 1-1/4-11-1/2 |
| 24MP-24MP | G60110-2424 | G60110-2424 | 7253-23825 | 1-1/2-11-1/2 | 1-1/2-11-1/2 |
| 32MP-32MP | G60110-3232 | G60110-3232 | 7253-23835 | 2-11-1/2 | 2-11-1/2 |

EQUIPMENT

HOSE/CPLG. SELECTION

TECH. DATA

EXT. & VERY HIGH PRESS. HOSE

GS CPLGS.

PCM CPLGS.

PCS CPLGS.

HIGH & MED. PRESS. HOSE

MEGACRIMP® CPLGS.

PC CPLGS.

FIELD ATTACHABLE CPLGS.

AIR BRAKE HOSE & CPLGS.

MEGATECH® C5 HOSE & CPLGS.

LOW PRESS. HOSE & CPLGS.

C14 HOSE & CPLGS.

POLARSEAL® HOSE & CPLGS.

PWR. STG. HOSE & CPLGS.

THERMO-PLASTIC HOSE & CPLGS.

ADAPTERS

QUICK DISCONNECT CPLGS.

ACCESSORIES & ASSORTMENTS

PART NUMBER INDEXES



The World's Most Trusted Name in Belts, Hose and Hydraulics.

www.gates.com

L3

Adapters — SAE to SAE – G60 Series

For use up to SAE 100R2 maximum working pressure.

Male Pipe NPTF to Male Pipe NPTF – 90°

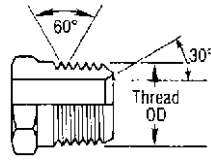

NPTF Solid Male (MP)



| DESCR | # | | | MP NPTF | FPS (NPTF) |
|-------------|-------|-------------|------------|----------|------------|
| | 87650 | G60115-0202 | 7253-25205 | | |
| 2MP-2MP90 | 87650 | G60115-0202 | 7253-25205 | 1/8-27 | |
| 4MP-4MP90 | 87651 | G60115-0404 | 7253-25215 | 1/4-18 | |
| 6MP-6MP90 | 87652 | G60115-0606 | 7253-25225 | 3/8-18 | |
| 8MP-8MP90 | 87653 | G60115-0808 | 7253-25235 | 1/2-14 | |
| 12MP-12MP90 | 87654 | G60115-1212 | 7253-25245 | 3/4-14 | |
| 16MP-16MP90 | 87655 | G60115-1616 | 7253-25255 | 1-11-1/2 | |

Male Pipe NPTF to Female Pipe NPTF Reducer/Bushing – Short

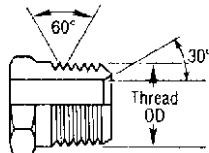

NPTF Solid Male (MP)

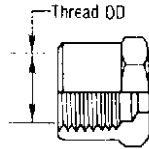

NPTF or NPSF Solid Female (FP)



| DESCR | # | | | MP NPTF | FPS (NPTF) |
|------------|-------------|-------------|------------|--------------|--------------|
| | 87400 | G60130-0402 | 7253-22595 | 1/4-18 | 1/8-27 |
| 4MP-2FPS | 87400 | G60130-0402 | 7253-22595 | 1/4-18 | 1/8-27 |
| 6MP-2FPS | 87401 | G60130-0602 | 7253-22605 | 3/8-18 | 1/8-27 |
| 6MP-4FPS | 87402 | G60130-0604 | 7253-22615 | 3/8-18 | 1/4-18 |
| 8MP-4FPS | 87404 | G60130-0804 | 7253-22635 | 1/2-14 | 1/4-18 |
| 8MP-6FPS | 87405 | G60130-0806 | 7253-22645 | 1/2-14 | 3/8-18 |
| 12MP-4FPS | 87406 | G60130-1204 | 7253-22665 | 3/4-14 | 1/4-18 |
| 12MP-6FPS | 87407 | G60130-1206 | 7253-22675 | 3/4-14 | 3/8-18 |
| 12MP-8FPS | 87408 | G60130-1208 | 7253-22685 | 3/4-14 | 1/2-14 |
| 16MP-8FPS | 87410 | G60130-1608 | 7253-22725 | 1-11-1/2 | 1/2-14 |
| 16MP-12FPS | 87411 | G60130-1612 | 7253-22735 | 1-11-1/2 | 3/4-14 |
| 20MP-12FPS | 87412 | G60130-2012 | 7253-22755 | 1-1/4-11-1/2 | 3/4-14 |
| 20MP-16FPS | 87413 | G60130-2016 | 7253-22765 | 1-1/4-11-1/2 | 1-11-1/2 |
| 24MP-12FPS | 87414 | G60130-2412 | 7253-22785 | 1-1/2-11-1/2 | 3/4-14 |
| 24MP-16FPS | 87415 | G60130-2416 | 7253-22795 | 1-1/2-11-1/2 | 1-11-1/2 |
| 24MP-20FPS | 87416 | G60130-2420 | 7253-22805 | 1-1/2-11-1/2 | 1-1/4-11-1/2 |
| 32MP-24FPS | G60130-3224 | G60130-3224 | 7253-32825 | 2-11-1/2 | 1-1/2-11-1/2 |

Adapters — SAE to SAE – G60 Series

For use up to SAE 100R2 maximum working pressure.

Male Pipe NPTF to Female Pipe NPTF Increase/Bushing – Long

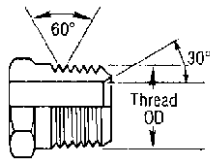

NPTF Solid Male (MP)

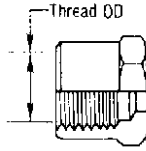

NPTF or NPSF Solid Female (FP)



| Descr | # | | |  | |
|------------|-------|-------------|------------|---|--------------|
| | | | | MP (NPTF) | FPL (NPTF) |
| 2MP-4FPL | 87691 | G60132-0204 | 7253-25365 | 1/8-27 | 1/4-18 |
| 4MP-6FPL | 87693 | G60132-0406 | 7253-25385 | 1/4-18 | 3/8-18 |
| 6MP-8FPL | 87696 | G60132-0608 | 7253-25415 | 3/8-18 | 1/2-14 |
| 8MP-12FPL | 87698 | G60132-0812 | 7253-25435 | 1/2-14 | 3/4-14 |
| 12MP-16FPL | 87700 | G60132-1216 | 7253-25455 | 3/4-14 | 1-11-1/2 |
| 16MP-20FPL | 87702 | G60132-1620 | 7253-25475 | 1-11-1/2 | 1-1/4-11-1/2 |
| 20MP-24FPL | 87704 | G60132-2024 | 7253-25495 | 1-1/4-11-1/2 | 1-1/2-11-1/2 |

Male Pipe NPTF to Female Pipe NPTF – 90°

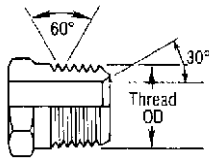

NPTF Solid Male (MP)

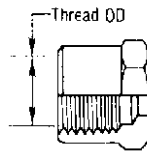

NPTF or NPSF Solid Female (FP)



| Descr | # | | |  | |
|-------------|-------------|-------------|------------|---|--------------|
| | | | | MP (NPTF) | FP (NPTF) |
| 2MP-2FP90 | 87490 | G60136-0202 | 7253-24105 | 1/8-27 | 1/8-27 |
| 2MP-4FP90 | G60136-0204 | G60136-0204 | 7253-32835 | 1/8-27 | 1/4-18 |
| 4MP-2FP90 | G60136-0402 | G60136-0402 | 7253-32845 | 1/4-18 | 1/8-27 |
| 4MP-4FP90 | 87491 | G60136-0404 | 7253-24115 | 1/4-18 | 1/4-18 |
| 4MP-6FP90 | G60136-0406 | G60136-0406 | 7253-32855 | 1/4-18 | 3/8-18 |
| 6MP-4FP90 | G60136-0604 | G60136-0604 | 7253-32865 | 3/8-18 | 1/4-18 |
| 6MP-6FP90 | 87492 | G60136-0606 | 7253-24125 | 3/8-18 | 3/8-18 |
| 6MP-8FP90 | G60136-0608 | G60136-0608 | 7253-32875 | 3/8-18 | 1/2-14 |
| 8MP-6FP90 | G60136-0806 | G60136-0806 | 7253-32885 | 1/2-14 | 3/8-18 |
| 8MP-8FP90 | 87493 | G60136-0808 | 7253-24135 | 1/2-14 | 1/2-14 |
| 8MP-12FP90 | G60136-0812 | G60136-0812 | 7253-32895 | 1/2-14 | 3/4-14 |
| 12MP-8FP90 | G60136-1208 | G60136-1208 | 7253-32905 | 3/4-14 | 1/2-14 |
| 12MP-12FP90 | 87494 | G60136-1212 | 7253-24145 | 3/4-14 | 3/4-14 |
| 16MP-16FP90 | 87495 | G60136-1616 | 7253-24155 | 1-11-1/1 | 1-11-1/2 |
| 20MP-20FP90 | 87496 | G60136-2020 | 7253-24165 | 1-1/4-11-1/2 | 1-1/4-11-1/2 |
| 24MP-24FP90 | G60136-2424 | G60136-2424 | 7253-24175 | 1-1/2-11-1/2 | 1-1/2-11-1/2 |
| 32MP-32FP90 | G60136-3232 | G60136-3232 | 7253-24185 | 2-11-1/2 | 2-11-1/2 |

EQUIPMENT

HOSE/CPLG. SELECTION

TECH. DATA

EXT. & VERY HIGH PRESS. HOSE

GS CPLGS.

PCM CPLGS.

PCS CPLGS.

HIGH & MED. PRESS. HOSE

MEGACRIMP® CPLGS.

PC CPLGS.

FIELD ATTACHABLE CPLGS.

AIR BRAKE HOSE & CPLGS.

MEGATECH® C5 HOSE & CPLGS.

LOW PRESS. HOSE & CPLGS.

C14 HOSE & CPLGS.

POLARSEAL® HOSE & CPLGS.

PWR. STG. HOSE & CPLGS.

THERMO-PLASTIC HOSE & CPLGS.

ADAPTERS

QUICK DISCONNECT CPLGS.

ACCESSORIES & ASSORTMENTS

PART NUMBER INDEXES



The World's Most Trusted Name in Belts, Hose and Hydraulics.

www.gates.com

L5

Adapters — SAE to SAE – G60 Series

For use up to SAE 100R2 maximum working pressure.

Male Pipe NPTF to Female Pipe Swivel NPSM

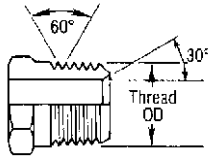

NPTF Solid Male (MP)

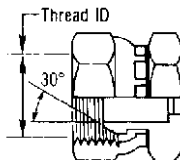

NPSM Swivel Female (FPX)



| Descr | # | | |  | |
|------------|-------------|-------------|------------|---|--------------|
| | | | | MP (NPTF) | FPX (NPSM) |
| 2MP-2FPX | 86301 | G60140-0202 | 7253-00735 | 1/8-27 | 1/8-27 |
| 2MP-4FPX | 86296 | G60140-0204 | 7253-86296 | 1/8-27 | 1/4-18 |
| 4MP-4FPX | 86302 | G60140-0404 | 7253-00775 | 1/4-18 | 1/4-18 |
| 4MP-6FPX | 86304 | G60140-0406 | 7253-86304 | 1/4-18 | 3/8-18 |
| 6MP-4FPX | 86303 | G60140-0604 | 7253-86303 | 3/8-18 | 1/4-18 |
| 6MP-6FPX | 86305 | G60140-0606 | 7253-00815 | 3/8-18 | 3/8-18 |
| 6MP-8FPX | 86307 | G60140-0608 | 7253-86307 | 3/8-18 | 1/2-14 |
| 8MP-6FPX | 86306 | G60140-0806 | 7253-86306 | 1/2-14 | 3/8-18 |
| 8MP-8FPX | 86308 | G60140-0808 | 7253-00895 | 1/2-14 | 1/2-14 |
| 8MP-12FPX | 86297 | G60140-0812 | 7253-86297 | 1/2-14 | 3/4-14 |
| 12MP-8FPX | 86309 | G60140-1208 | 7253-86309 | 3/4-14 | 1/2-14 |
| 12MP-12FPX | 86311 | G60140-1212 | 7253-00255 | 3/4-14 | 3/4-14 |
| 12MP-16FPX | G60140-1216 | G60140-1216 | 7253-32935 | 3/4-14 | 1-11-1/2 |
| 16MP-12FPX | 86312 | G60140-1612 | 7253-86312 | 1-11-1/2 | 3/4-14 |
| 16MP-16FPX | 86313 | G60140-1616 | 7253-00275 | 1-11-1/2 | 1-11-1/2 |
| 16MP-20FPX | 86298 | G60140-1620 | 7253-86298 | 1-11-1/2 | 1-1/4-11-1/2 |
| 20MP-20FPX | 86314 | G60140-2020 | 7253-86314 | 1-1/4-11-1/2 | 1-1/4-11-1/2 |
| 24MP-24FPX | 86315 | G60140-2424 | 7253-86315 | 1-1/2-11-1/2 | 1-1/2-11-1/2 |
| 32MP-32FPX | 86299 | G60140-3232 | 7253-86299 | 2-11-1/2 | 2-11-1/2 |

EQUIPMENT
HOSE/CPLG. SELECTION
TECH. DATA
EXT. & VERY HIGH PRESS. HOSE
GS CPLGS.
PCM CPLGS.
PCS CPLGS.
HIGH & MED. PRESS. HOSE
MEGACRIMP® CPLGS.
PC CPLGS.
FIELD ATTACHABLE CPLGS.
AIR BRAKE HOSE & CPLGS.
MEGATECH® C5 HOSE & CPLGS.
LOW PRESS. HOSE & CPLGS.
C14 HOSE & CPLGS.
POLARSEAL® HOSE & CPLGS.
PWR. STG. HOSE & CPLGS.
THERMO-PLASTIC HOSE & CPLGS.
ADAPTERS
QUICK DISCONNECT CPLGS.
ACCESSORIES & ASSORTMENTS
PART NUMBER INDEXES



Adapters — SAE to SAE – G60 Series

For use up to SAE 100R2 maximum working pressure.

Male Pipe NPTF to Female Pipe Swivel NPSM – 45°

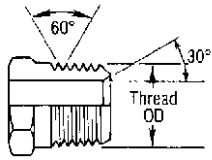

NPTF Solid Male (MP)

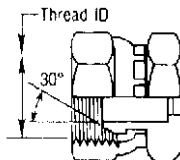

NPSM Swivel Female (FPX)



| Descr | # | | |  | |
|--------------|-------------|-------------|------------|---|--------------|
| | | | | MP (NPTF) | FPX (NPSM) |
| 2MP-2FPX45 | G60142-0202 | G60142-0202 | 7253-32945 | 1/8-27 | 1/8-27 |
| 4MP-4FPX45 | 86331 | G60142-0404 | 7253-02115 | 1/4-18 | 1/4-18 |
| 6MP-6FPX45 | 86333 | G60142-0606 | 7253-02155 | 3/8-18 | 3/8-18 |
| 6MP-8FPX45 | G60142-0608 | G60142-0608 | 7253-32955 | 3/8-18 | 1/2-14 |
| 8MP-6FPX45 | G60142-0806 | G60142-0806 | 7253-32965 | 1/2-14 | 3/8-18 |
| 8MP-8FPX45 | 86336 | G60142-0808 | 7253-02125 | 1/2-14 | 1/2-14 |
| 12MP-8FPX45 | 86337 | G60142-1208 | 7253-86337 | 3/4-14 | 1/2-14 |
| 12MP-12FPX45 | 86338 | G60142-1212 | 7253-02235 | 3/4-14 | 3/4-14 |
| 16MP-12FPX45 | 86339 | G60142-1612 | 7253-86339 | 1-11-1/2 | 3/4-14 |
| 16MP-16FPX45 | 86341 | G60142-1616 | 7253-86341 | 1-11-1/2 | 1-11-1/2 |
| 20MP-20FPX45 | 86342 | G60142-2020 | 7253-86342 | 1-1/4-11-1/2 | 1-1/4-11-1/2 |
| 24MP-24FPX45 | 86343 | G60142-2424 | 7253-86343 | 1-1/2-11-1/2 | 1-1/2-11-1/2 |
| 32MP-32FPX45 | G60142-3232 | G60142-3232 | 7253-32975 | 2-11-1/2 | 2-11-1/2 |

EQUIPMENT

HOSE/CPLG. SELECTION

TECH. DATA

EXT. & VERY HIGH PRESS. HOSE

GS CPLGS.

PCM CPLGS.

PCS CPLGS.

HIGH & MED. PRESS. HOSE

MEGACRIMP® CPLGS.

PC CPLGS.

FIELD ATTACHABLE CPLGS.

AIR BRAKE HOSE & CPLGS.

MEGATECH™ C5 HOSE & CPLGS.

LOW PRESS. HOSE & CPLGS.

C14 HOSE & CPLGS.

POLARSEAL® HOSE & CPLGS.

PWR. STG. HOSE & CPLGS.

THERMO-PLASTIC HOSE & CPLGS.

ADAPTERS

QUICK DISCONNECT CPLGS.

ACCESSORIES & ASSORTMENTS

PART NUMBER INDEXES



The World's Most Trusted Name in Belts, Hose and Hydraulics.

www.gates.com

L7

Adapters — SAE to SAE – G60 Series

For use up to SAE 100R2 maximum working pressure.

Male Pipe NPTF to Female Pipe Swivel NPSM – 90°

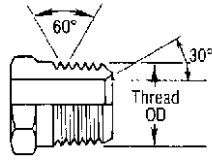

NPTF Solid Male (MP)

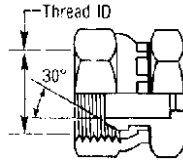

NPSM Swivel Female (FPX)



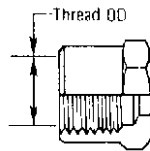

| Descr | # | | |  | |
|--------------|-------------|-------------|------------|---|--------------|
| | | | | MP (NPTF) | FPX (NPSM) |
| 2MP-2FPX90 | 86291 | G60144-0202 | 7253-08305 | 1/8-27 | 1/8-27 |
| 4MP-4FPX90 | 86316 | G60144-0404 | 7253-02135 | 1/4-18 | 1/4-18 |
| 4MP-6FPX90 | 86317 | G60144-0406 | 7253-86317 | 1/4-18 | 3/8-18 |
| 6MP-4FPX90 | 86318 | G60144-0604 | 7253-86318 | 3/8-18 | 1/4-18 |
| 6MP-6FPX90 | 86319 | G60144-0606 | 7253-02165 | 3/8-18 | 3/8-18 |
| 6MP-8FPX90 | 86292 | G60144-0608 | 7253-86292 | 3/8-18 | 1/2-14 |
| 8MP-4FPX90 | 86321 | G60144-0804 | 7253-86321 | 1/2-14 | 1/4-18 |
| 8MP-6FPX90 | 86293 | G60144-0806 | 7253-86293 | 1/2-14 | 3/8-18 |
| 8MP-8FPX90 | 86322 | G60144-0808 | 7253-02205 | 1/2-14 | 1/2-14 |
| 8MP-12FPX90 | 86294 | G60144-0812 | 7253-86294 | 1/2-14 | 3/4-14 |
| 12MP-8FPX90 | 86323 | G60144-1208 | 7253-02245 | 3/4-14 | 1/2-14 |
| 12MP-12FPX90 | 86324 | G60144-1212 | 7253-02265 | 3/4-14 | 3/4-14 |
| 16MP-12FPX90 | G60144-1612 | G60144-1612 | 7253-86325 | 1-11-1/2 | 3/4-14 |
| 16MP-16FPX90 | 86326 | G60144-1616 | 7253-86326 | 1-11-1/2 | 1-11-1/2 |
| 16MP-20FPX90 | 86327 | G60144-1620 | 7253-86327 | 1-11-1/2 | 1-1/4-11-1/2 |
| 20MP-20FPX90 | 86328 | G60144-2020 | 7253-86328 | 1-1/4-11-1/2 | 1-1/4-11-1/2 |
| 24MP-24FPX90 | 86329 | G60144-2424 | 7253-86329 | 1-1/2-11-1/2 | 1-1/2-11-1/2 |
| 32MP-32FPX90 | G60144-3232 | G60144-3232 | 7253-32995 | 2-11-1/2 | 2-11-1/2 |

Female Pipe NPTF to Female Pipe NPTF

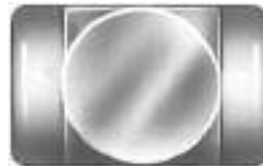

NPTF or NPSF Solid Female (FP)



| Descr | # | | |  | |
|-----------|-------------|-------------|------------|---|------------|
| | | | | MP (NPTF) | FPX (NPSM) |
| 2FP-2FP | 87530 | G60152-0202 | 7253-24415 | 1/8-27 | |
| 4FP-4FP | 87531 | G60152-0404 | 7253-24425 | 1/4-18 | |
| 6FP-6FP | 87532 | G60152-0606 | 7253-24435 | 3/8-18 | |
| 8FP-8FP | 87533 | G60152-0808 | 7253-24445 | 1/2-14 | |
| 12FP-12FP | 87534 | G60152-1212 | 7253-24455 | 3/4-14 | |
| 16FP-16FP | 87535 | G60152-1616 | 7253-24465 | 1-11-1/2 | |
| 20FP-20FP | 87536 | G60152-2020 | 7253-24475 | 1-1/4-11-1/2 | |
| 24FP-24FP | G60152-2424 | G60152-2424 | 7253-24885 | 1-1/2-11-1/2 | |
| 32FP-32FP | G60152-3232 | G60152-3232 | 7253-24895 | 2-11-1/2 | |

Adapters — SAE to SAE – G60 Series

For use up to SAE 100R2 maximum working pressure.

Female Pipe NPTF to Female Pipe NPTF – 90°

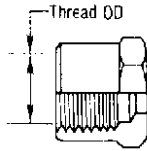

NPTF or NPSF Solid Female (FP)



| Descr | # | | |  | |
|-------------|-------------|-------------|------------|---|--------------|
| | | | | FP (NPTF) | FP (NPTF) |
| 2FP-2FP90 | 87630 | G60156-0202 | 7253-25015 | 1/8-27 | 1/8-27 |
| 4FP-2FP90 | G60156-0402 | G60156-0402 | 7253-33005 | 1/4-18 | 1/8-27 |
| 4FP-4FP90 | 87631 | G60156-0404 | 7253-25025 | 1/4-18 | 1/4-18 |
| 6FP-4FP90 | G60156-0604 | G60156-0604 | 7253-33015 | 3/8-18 | 1/4-18 |
| 6FP-6FP90 | 87632 | G60156-0606 | 7253-25035 | 3/8-18 | 3/8-18 |
| 8FP-6FP90 | G60156-0604 | G60156-0806 | 7253-33025 | 1/2-14 | 3/8-18 |
| 8FP-8FP90 | 87633 | G60156-0808 | 7253-25045 | 1/2-14 | 1/2-14 |
| 12FP-8FP90 | G60156-1208 | G60156-1208 | 7253-33035 | 3/4-14 | 1/2-14 |
| 12FP-12FP90 | 87634 | G60156-1212 | 7253-25055 | 3/4-14 | 3/4-14 |
| 16FP-16FP90 | 87635 | G60156-1616 | 7253-25065 | 1-11-1/2 | 1-11-1/2 |
| 20FP-20FP90 | 87636 | G60156-2020 | 7253-25075 | 1-1/4-11-1/2 | 1-1/4-11-1/2 |
| 24FP-24FP90 | G60156-2424 | G60156-2424 | 7253-33055 | 1-1/2-11-1/2 | 1-1/2-11-1/2 |

Female Pipe NPTF to Female Pipe Swivel NPSM

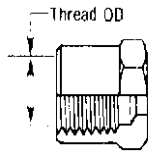

NPTF or NPSF Solid Female (FP)

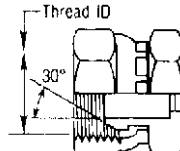

NPSM Swivel Female (FPX)

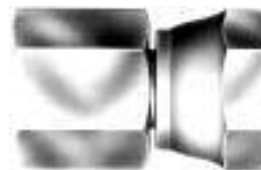

| Descr | # | | |  | |
|------------|-------------|-------------|------------|---|--------------|
| | | | | FP (NPTF) | FPX (NPSM) |
| 4FP-4FPX | 86345 | G60160-0404 | 7253-00795 | 1/4-18 | 1/4-18 |
| 6FP-4FPX | G60160-0604 | G60160-0604 | 7253-33085 | 3/8-18 | 1/4-18 |
| 6FP-6FPX | 86346 | G60160-0606 | 7253-00835 | 3/8-18 | 3/8-18 |
| 8FP-6FPX | G60160-0806 | G60160-0806 | 7253-33095 | 1/2-14 | 3/8-18 |
| 8FP-8FPX | 86347 | G60160-0808 | 7253-00915 | 1/2-14 | 1/2-14 |
| 12FP-12FPX | 86348 | G60160-1212 | 7253-00925 | 3/4-14 | 3/4-14 |
| 16FP-12FPX | 86349 | G60160-1612 | 7253-86349 | 1-11-1/2 | 3/4-14 |
| 16FP-16FPX | 86351 | G60160-1616 | 7253-00905 | 1-11-1/2 | 1-11-1/2 |
| 20FP-20FPX | 86352 | G60160-2020 | 7253-86352 | 1-1/4-11-1/2 | 1-1/4-11-1/2 |
| 24FP-24FPX | 86353 | G60160-2424 | 7253-86353 | 1-1/2-11-1/2 | 1-1/2-11-1/2 |
| 32FP-32FPX | 86295 | G60160-3232 | 7253-86295 | 2-11-1/2 | 2-11-1/2 |

EQUIPMENT

HOSE/CPLG. SELECTION

TECH. DATA

EXT. & VERY HIGH PRESS. HOSE

GS CPLGS.

PCM CPLGS.

PCS CPLGS.

HIGH & MED. PRESS. HOSE

MEGACRIMP® CPLGS.

PC CPLGS.

FIELD ATTACHABLE CPLGS.

AIR BRAKE HOSE & CPLGS.

MEGATECH® C5 HOSE & CPLGS.

LOW PRESS. HOSE & CPLGS.

C14 HOSE & CPLGS.

POLARSEAL® HOSE & CPLGS.

PWR. STG. HOSE & CPLGS.

THERMO-PLASTIC HOSE & CPLGS.

ADAPTERS

QUICK DISCONNECT CPLGS.

ACCESSORIES & ASSORTMENTS

PART NUMBER INDEXES



The World's Most Trusted Name in Belts, Hose and Hydraulics.

www.gates.com

L9

Adapters — SAE to SAE – G60 Series

For use up to SAE 100R2 maximum working pressure.

Female Pipe NPTF to Female Pipe Swivel NPSM – 45°

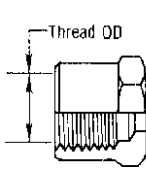

NPTF or NPSF Solid Female (FP)

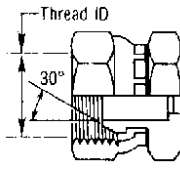

NPSM Swivel Female (FPX)



| Descr | # | | |  | |
|--------------|-------------|-------------|------------|---|--------------|
| | | | | FP (NPTF) | FPX (NPSM) |
| 4FP-4FPX45 | 86362 | G60162-0404 | 7253-86362 | 1/4-18 | 1/4-18 |
| 6FP-6FPX45 | 86363 | G60162-0606 | 7253-86363 | 3/8-18 | 3/8-18 |
| 8FP-8FPX45 | 86364 | G60162-0808 | 7253-86364 | 1/2-14 | 1/2-14 |
| 12FP-12FPX45 | 86365 | G60162-1212 | 7253-86365 | 3/4-14 | 3/4-14 |
| 16FP-16FPX45 | 86366 | G60162-1616 | 7253-86366 | 1-11-1/2 | 1-11-1/2 |
| 20FP-20FPX45 | G60162-2020 | G60162-2020 | 7253-33105 | 1-1/4-11-1/2 | 1-1/4-11-1/2 |

Female Pipe NPTF to Female Pipe Swivel NPSM – 90°

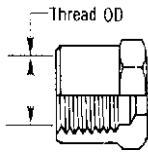

NPTF or NPSF Solid Female (FP)

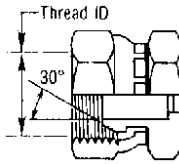

NPSM Swivel Female (FPX)



| Descr | # | | |  | |
|--------------|-------------|-------------|------------|---|--------------|
| | | | | FP (NPTF) | FPX (NPSM) |
| 4FP-4FPX90 | 86354 | G60164-0404 | 7253-86354 | 1/4-18 | 1/4-18 |
| 6FP-6FPX90 | 86355 | G60164-0606 | 7253-86355 | 3/8-18 | 3/8-18 |
| 8FP-8FPX90 | 86356 | G60164-0808 | 7253-86356 | 1/2-14 | 1/2-14 |
| 12FP-12FPX90 | 86357 | G60164-1212 | 7253-86357 | 3/4-14 | 3/4-14 |
| 16FP-16FPX90 | 86358 | G60164-1616 | 7253-86358 | 1-11-1/2 | 1-11-1/2 |
| 20FP-20FPX90 | G60164-2020 | G60164-2020 | 7253-33115 | 1-1/4-11-1/2 | 1-1/4-11-1/2 |
| 24FP-24FPX90 | G60164-2424 | G60164-2424 | 7253-33125 | 1-1/2-11-1/2 | 1-1/2-11-1/2 |
| 32FP-32FPX90 | G60164-3232 | G60164-3232 | 7253-33135 | 2-11-1/2 | 2-11-1/2 |

EQUIPMENT
HOSE/CPLG. SELECTION
TECH. DATA
EXT. & VERY HIGH PRESS. HOSE
GS CPLGS.
PCM CPLGS.
PCS CPLGS.
HIGH & MED. PRESS. HOSE
MEGACRIMP® CPLGS.
PC CPLGS.
FIELD ATTACHABLE CPLGS.
AIR BRAKE HOSE & CPLGS.
MEGATECH® C5 HOSE & CPLGS.
LOW PRESS. HOSE & CPLGS.
C14 HOSE & CPLGS.
POLARSEAL® HOSE & CPLGS.
PWR. STG. HOSE & CPLGS.
THERMO-PLASTIC HOSE & CPLGS.
ADAPTERS
QUICK DISCONNECT CPLGS.
ACCESSORIES & ASSORTMENTS
PART NUMBER INDEXES



Adapters – SAE to SAE – G60 Series

For use up to SAE 100R2 maximum working pressure.

Female Pipe NPTF – Tee

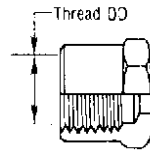

NPTF or NPSF Solid Female (FP)

| Descr | # | | |  |
|----------------|-------------|-------------|------------|---|
| 2FP-2FP-2FP | 87610 | G60181-0202 | 7253-23145 | 1/8-27 |
| 4FP-4FP-4FP | 87611 | G60181-0404 | 7253-23155 | 1/4-18 |
| 6FP-6FP-6FP | 87612 | G60181-0606 | 7253-23165 | 3/8-18 |
| 8FP-8FP-8FP | 87613 | G60181-0808 | 7253-23175 | 1/2-14 |
| 12FP-12FP-12FP | 87614 | G60181-1212 | 7253-23185 | 3/4-14 |
| 16FP-16FP-16FP | 87615 | G60181-1616 | 7253-23195 | 1-11-1/2 |
| 20FP-20FP-20FP | G60181-2020 | G60181-2020 | 7253-33145 | 1-1/4-11-1/2 |
| 24FP-24FP-24FP | G60181-2424 | G60181-2424 | 7253-33155 | 1-1/2-11-1/2 |

Female Pipe NPTF on Run to Male Pipe NPTF – Tee

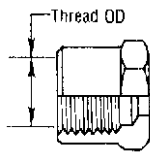

NPTF or NPSF Solid Female (FP)

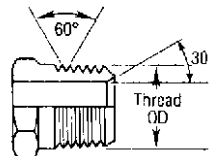

NPTF Solid Male (MP)



| Descr | # | | |  | |
|----------------|-------|-------------|------------|---|-----------|
| | | | | FP (NPTF) | MP (NPTF) |
| 2FP-2FP-2MP | 87620 | G60183-0202 | 7253-24905 | 1/8-27 | 1/8-27 |
| 4FP-4FP-4MP | 87621 | G60183-0404 | 7253-24915 | 1/4-18 | 1/4-18 |
| 6FP-6FP-6MP | 87622 | G60183-0606 | 7253-24925 | 3/8-18 | 3/8-18 |
| 8FP-8FP-8MP | 87623 | G60183-0808 | 7253-24935 | 1/2-14 | 1/2-14 |
| 12FP-12FP-12MP | 87624 | G60183-1212 | 7253-24945 | 3/4-14 | 3/4-14 |
| 16FP-16FP-16MP | 87625 | G60183-1616 | 7253-24955 | 1-11-1/2 | 1-11-1/2 |

EQUIPMENT

HOSE/CPLG. SELECTION

TECH. DATA

EXT. & VERY HIGH PRESS. HOSE

GS CPLGS.

PCM CPLGS.

PCS CPLGS.

HIGH & MED. PRESS. HOSE

MEGACRIMP® CPLGS.

PC CPLGS.

FIELD ATTACHABLE CPLGS.

AIR BRAKE HOSE & CPLGS.

MEGATECH® C5 HOSE & CPLGS.

LOW PRESS. HOSE & CPLGS.

C14 HOSE & CPLGS.

POLARSEAL® HOSE & CPLGS.

PWR. STG. HOSE & CPLGS.

THERMO-PLASTIC HOSE & CPLGS.

ADAPTERS

QUICK DISCONNECT CPLGS.

ACCESSORIES & ASSORTMENTS

PART NUMBER INDEXES



The World's Most Trusted Name in Belts, Hose and Hydraulics.

www.gates.com

L11

Adapters — SAE to SAE – G60 Series

For use up to SAE 100R2 maximum working pressure.

Female Pipe Swivel NPSM – Tee

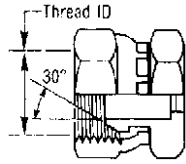

NPSM Swivel Female (FPX)



| Descr | # | | | |
|-------------------|-------------|-------------|------------|--------------|
| 2FPX-2FPX-2FPX | G60184-0202 | G60184-0202 | 7253-33165 | 1/8-27 |
| 4FPX-4FPX-4FPX | G60184-0404 | G60184-0404 | 7253-33175 | 1/4-18 |
| 6FPX-6FPX-6FPX | G60184-0606 | G60184-0606 | 7253-33185 | 3/8-18 |
| 8FPX-8FPX-8FPX | G60184-0808 | G60184-0808 | 7253-33195 | 1/2-14 |
| 12FPX-12FPX-12FPX | G60184-1212 | G60184-1212 | 7253-33205 | 3/4-14 |
| 16FPX-16FPX-16FPX | G60184-1616 | G60184-1616 | 7253-33215 | 1-11-1/2 |
| 20FPX-20FPX-20FPX | G60184-2020 | G60184-2020 | 7253-33225 | 1-1/4-11-1/2 |

Female Pipe Swivel NPSM on Run to Male Pipe NPTF – Tee

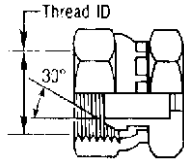

NPSM Swivel Female (FPX)

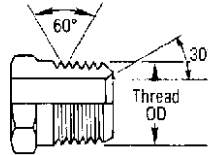

NPTF Solid Male (MP)



| Descr | # | | | | |
|------------------|-------------|-------------|------------|--------------|--------------|
| | | | | FPX (NPSM) | MP (NPTF) |
| 2FPX-2FPX-2MP | 86585 | G60186-0202 | 7253-86585 | 1/8-27 | 1/8-27 |
| 4FPX-4FPX-4MP | 86586 | G60186-0404 | 7253-86586 | 1/4-18 | 1/4-18 |
| 6FPX-6FPX-6MP | 86587 | G60186-0606 | 7253-86587 | 3/8-18 | 3/8-18 |
| 8FPX-8FPX-8MP | 86588 | G60186-0808 | 7253-86588 | 1/2-14 | 1/2-14 |
| 12FPX-12FPX-12MP | 86589 | G60186-1212 | 7253-86589 | 3/4-14 | 3/4-14 |
| 16FPX-16FPX-16MP | 86591 | G60186-1616 | 7253-86591 | 1-11-1/2 | 1-11-1/2 |
| 20FPX-20FPX-20MP | G60186-2020 | G60186-2020 | 7253-33235 | 1-1/4-11-1/2 | 1-1/4-11-1/2 |

EQUIPMENT
HOSE/CPLG. SELECTION
TECH. DATA
EXT. & VERY HIGH PRESS. HOSE
GS CPLGS.
PCM CPLGS.
PCS CPLGS.
HIGH & MED. PRESS. HOSE
MEGACRIMP® CPLGS.
PC CPLGS.
FIELD ATTACHABLE CPLGS.
AIR BRAKE HOSE & CPLGS.
MEGATECH®/C5 HOSE & CPLGS.
LOW PRESS. HOSE & CPLGS.
C14 HOSE & CPLGS.
POLARSEAL® HOSE & CPLGS.
PWR. STG. HOSE & CPLGS.
THERMO-PLASTIC HOSE & CPLGS.
ADAPTERS
QUICK DISCONNECT CPLGS.
ACCESSORIES & ASSORTMENTS
PART NUMBER INDEXES



Adapters — SAE to SAE – G60 Series



For use up to SAE 100R2 maximum working pressure.

Male O-Ring Boss Plug

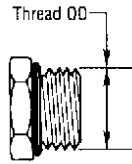

O-Ring Boss Male (MB)

| Descr | # | | | | O-Ring # | | |
|-----------|-------|-------------|------------|-----------|----------|-------------|-----------|
| | | | | | | | |
| 4MB-PLUG | 87540 | G60250-0004 | 7253-22975 | 7/16-20 | 82501 | G60248-0004 | 7254-0004 |
| 5MB-PLUG | 87541 | G60250-0005 | 7253-22985 | 1/2-20 | 82502 | G60248-0005 | 7254-0005 |
| 6MB-PLUG | 87542 | G60250-0006 | 7253-22995 | 9/16-18 | 82503 | G60248-0006 | 7254-0006 |
| 8MB-PLUG | 87543 | G60250-0008 | 7253-23005 | 3/4-16 | 82504 | G60248-0008 | 7254-0008 |
| 10MB-PLUG | 87544 | G60250-0010 | 7253-23015 | 7/8-14 | 82505 | G60248-0010 | 7254-0010 |
| 12MB-PLUG | 87545 | G60250-0012 | 7253-23025 | 1-1/16-12 | 82506 | G60248-0012 | 7254-0012 |
| 14MB-PLUG | 87546 | G60250-0014 | 7253-23035 | 1-3/16-12 | 82507 | G60248-0014 | 7254-0014 |
| 16MB-PLUG | 87547 | G60250-0016 | 7253-23045 | 1-5/16-12 | 82508 | G60248-0016 | 7254-0016 |
| 20MB-PLUG | 87548 | G60250-0020 | 7253-23055 | 1-5/8-12 | 82509 | G60248-0020 | 7254-0020 |

Male O-Ring Boss to Female Pipe NPTF

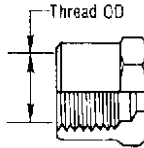
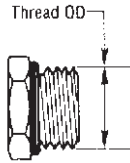

O-Ring Boss Male (MB)

NPTF or NPSF Solid Female (FP)

| Descr | # | | | | | O-Ring # | | |
|-----------|-------------|-------------|------------|-----------|-----------|----------|-------------|-----------|
| | | | | MB | FP (NPTF) | | | |
| 4MB-2FP | 87500 | G60275-0402 | 7253-24205 | 7/16-20 | 1/8-27 | 82501 | G60248-0004 | 7254-0004 |
| 6MB-4FP | 87501 | G60275-0604 | 7253-24215 | 9/16-18 | 1/4-18 | 82503 | G60248-0006 | 7254-0006 |
| 8MB-6FP | 87502 | G60275-0806 | 7253-24225 | 3/4-16 | 3/8-18 | 82504 | G60248-0008 | 7254-0008 |
| 8MB-8FP | G60275-0808 | G60275-0808 | 7253-33255 | 3/4-16 | 1/2-14 | 82504 | G60248-0008 | 7254-0008 |
| 10MB-8FP | 87503 | G60275-1008 | 7253-24235 | 7/8-14 | 1/2-14 | 82505 | G60248-0010 | 7254-0010 |
| 12MB-8FP | 87504 | G60275-1208 | 7253-24245 | 1-1/16-12 | 1/2-14 | 82506 | G60248-0012 | 7254-0012 |
| 12MB-12FP | 87505 | G60275-1212 | 7253-24255 | 1-1/16-12 | 3/4-14 | 82506 | G60248-0012 | 7254-0012 |
| 14MB-12FP | 87506 | G60275-1412 | 7253-24265 | 1-3/16-12 | 3/4-14 | 82507 | G60248-0014 | 7254-0014 |
| 16MB-12FP | G60275-1612 | G60275-1612 | 7253-33265 | 1-5/16-12 | 3/4-14 | 82508 | G60248-0016 | 7254-0016 |
| 16MB-16FP | 87507 | G60275-1616 | 7253-24275 | 1-5/16-12 | 1-11-1/2 | 82508 | G60248-0016 | 7254-0016 |

EQUIPMENT

HOSE/CPLG. SELECTION

TECH. DATA

EXT. & VERY HIGH PRESS. HOSE

GS CPLGS.

PCM CPLGS.

PCS CPLGS.

HIGH & MED. PRESS. HOSE

MEGACRIMP® CPLGS.

PC CPLGS.

FIELD ATTACHABLE CPLGS.

AIR BRAKE HOSE & CPLGS.

MEGATECH® C5 HOSE & CPLGS.

LOW PRESS. HOSE & CPLGS.

C14 HOSE & CPLGS.

POLARSEAL® HOSE & CPLGS.

PWR. STG. HOSE & CPLGS.

THERMO-PLASTIC HOSE & CPLGS.

ADAPTERS

QUICK DISCONNECT CPLGS.

ACCESSORIES & ASSORTMENTS

PART NUMBER INDEXES



Adapters — SAE to SAE – G60 Series

For use up to SAE 100R2 maximum working pressure.

Male O-Ring Boss to Female Pipe Swivel NPSM

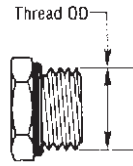

O-Ring Boss Male (MB)

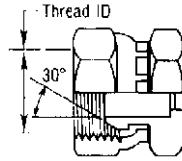

NPSM Swivel Female (FPX)



| Descr | # | | | 🌀 | | O-Ring # | | |
|------------|-------------|-------------|------------|-----------|------------|----------|-------------|-----------|
| | | | | MB | FPX (NPSM) | | | |
| 4MB-4FPX | 86959 | G60285-0404 | 7253-86959 | 7/16-20 | 1/4-18 | 82501 | G60248-0004 | 7254-0004 |
| 5MB-4FPX | 86961 | G60285-0504 | 7253-86961 | 1/2-20 | 1/4-18 | 82502 | G60248-0005 | 7254-0005 |
| 6MB-4FPX | 86963 | G60285-0604 | 7253-86963 | 9/16-18 | 1/4-18 | 82503 | G60248-0006 | 7254-0006 |
| 6MB-6FPX | 86964 | G60285-0606 | 7253-86964 | 9/16-18 | 3/8-18 | 82503 | G60248-0006 | 7254-0006 |
| 8MB-4FPX | 86965 | G60285-0804 | 7253-86965 | 3/4-16 | 1/4-18 | 82504 | G60248-0008 | 7254-0008 |
| 8MB-6FPX | 86966 | G60285-0806 | 7253-86966 | 3/4-16 | 3/8-18 | 82504 | G60248-0008 | 7254-0008 |
| 8MB-8FPX | 86967 | G60285-0808 | 7253-00295 | 3/4-16 | 1/2-14 | 82504 | G60248-0008 | 7254-0008 |
| 8MB-12FPX | 86968 | G60285-0812 | 7253-86968 | 3/4-16 | 3/4-14 | 82504 | G60248-0008 | 7254-0008 |
| 10MB-6FPX | 86969 | G60285-1006 | 7253-86969 | 7/8-14 | 3/8-18 | 82505 | G60248-0010 | 7254-0010 |
| 10MB-8FPX | 86971 | G60285-1008 | 7253-86971 | 7/8-14 | 1/2-14 | 82505 | G60248-0010 | 7254-0010 |
| 10MB-12FPX | 86972 | G60285-1012 | 7253-86972 | 7/8-14 | 3/4-14 | 82505 | G60248-0010 | 7254-0010 |
| 12MB-8FPX | 86973 | G60285-1208 | 7253-86973 | 1-1/16-12 | 1/2-14 | 82506 | G60248-0012 | 7254-0012 |
| 12MB-12FPX | 86974 | G60285-1212 | 7253-86974 | 1-1/16-12 | 3/4-14 | 82506 | G60248-0012 | 7254-0012 |
| 14MB-12FPX | G60285-1412 | G60285-1412 | 7253-33275 | 1-3/16-12 | 3/4-14 | 82507 | G60248-0014 | 7254-0014 |
| 16MB-16FPX | G60285-1616 | G60285-1616 | 7253-33285 | 1-5/16-12 | 1-11-1/2 | 82508 | G60248-0016 | 7254-0016 |

Male O-Ring Boss to Female Pipe Swivel NPSM – 45°

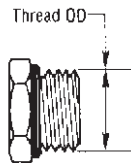

O-Ring Boss Male (MB)

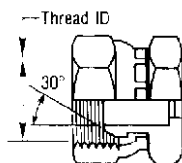

NPSM Swivel Female (FPX)



| Descr | # | | | 🌀 | | O-Ring # | | |
|--------------|-------------|-------------|------------|-----------|------------|----------|-------------|-----------|
| | | | | MB | FPX (NPSM) | | | |
| 6MB-6FPX45 | 86865 | G60287-0606 | 7253-86865 | 9/16-18 | 3/8-18 | 82503 | G60248-0006 | 7254-0006 |
| 8MB-6FPX45 | 86866 | G60287-0806 | 7253-86866 | 3/4-16 | 3/8-18 | 82504 | G60248-0008 | 7254-0008 |
| 8MB-8FPX45 | 86867 | G60287-0808 | 7253-86867 | 3/4-16 | 1/2-14 | 82504 | G60248-0008 | 7254-0008 |
| 8MB-12FPX45 | G60287-0812 | G60287-0812 | 7253-33295 | 3/4-16 | 3/4-14 | 82504 | G60248-0008 | 7254-0008 |
| 10MB-6FPX45 | 86868 | G60287-1006 | 7253-86868 | 7/8-14 | 3/8-18 | 82505 | G60248-0010 | 7254-0010 |
| 10MB-8FPX45 | 86869 | G60287-1008 | 7253-86869 | 7/8-14 | 1/2-14 | 82505 | G60248-0010 | 7254-0010 |
| 12MB-12FPX45 | 86871 | G60287-1212 | 7253-86871 | 1-1/16-12 | 3/4-14 | 82506 | G60248-0012 | 7254-0012 |
| 16MB-16FPX45 | G60287-1616 | G60287-1616 | 7253-33325 | 1-5/16-12 | 1-11-1/2 | 82508 | G60248-0016 | 7254-0016 |

Adapters — SAE to SAE – G60 Series



For use up to SAE 100R2 maximum working pressure.

Male O-Ring Boss to Female Pipe Swivel NPSM – 90°

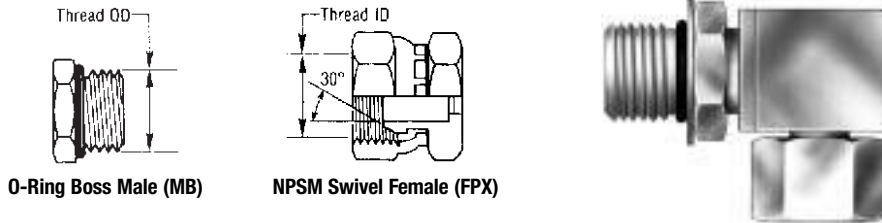

| Descr | # | | | | | O-Ring # | | |
|--------------|-------|-------------|------------|-----------|------------|----------|-------------|-----------|
| | | | | MB | FPX (NPSM) | | | |
| 4MB-4FPX90 | 86872 | G60289-0404 | 7253-86872 | 7/16-20 | 1/4-18 | 82501 | G60248-0004 | 7254-0004 |
| 6MB-4FPX90 | 86873 | G60289-0604 | 7253-86873 | 9/16-18 | 1/4-18 | 82503 | G60248-0006 | 7254-0006 |
| 6MB-6FPX90 | 86874 | G60289-0606 | 7253-86874 | 9/16-18 | 3/8-18 | 82503 | G60248-0006 | 7254-0006 |
| 8MB-6FPX90 | 86875 | G60289-0806 | 7253-86875 | 3/4-16 | 3/8-18 | 82504 | G60248-0008 | 7254-0008 |
| 8MB-8FPX90 | 86876 | G60289-0808 | 7253-86876 | 3/4-16 | 1/2-14 | 82504 | G60248-0008 | 7254-0008 |
| 8MB-12FPX90 | 86877 | G60289-0812 | 7253-86877 | 3/4-16 | 3/4-14 | 82504 | G60248-0008 | 7254-0008 |
| 10MB-6FPX90 | 86878 | G60289-1006 | 7253-86878 | 7/8-14 | 3/8-18 | 82505 | G60248-0010 | 7254-0010 |
| 10MB-8FPX90 | 86879 | G60289-1008 | 7253-86879 | 7/8-14 | 1/2-14 | 82505 | G60248-0010 | 7254-0010 |
| 10MB-12FPX90 | 86881 | G60289-1012 | 7253-86881 | 7/8-14 | 3/4-14 | 82505 | G60248-0010 | 7254-0010 |
| 12MB-12FPX90 | 86882 | G60289-1212 | 7253-86882 | 1-1/16-12 | 3/4-14 | 82506 | G60248-0012 | 7254-0012 |
| 16MB-16FPX90 | 86883 | G60289-1616 | 7253-86883 | 1-5/16-12 | 1-11-1/2 | 82508 | G60248-0016 | 7254-0016 |

Female O-Ring Boss to Male Pipe NPTF

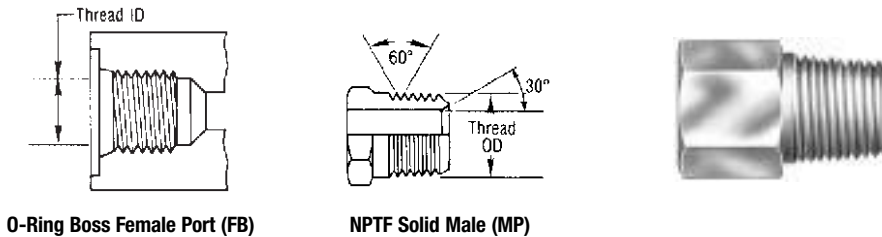

| Descr | # | | | |
|-----------|-------------|------------|-----------|-----------|
| | | | FB | MP (NPTF) |
| 4FB-2MP | G60291-0402 | 7253-33335 | 7/16-20 | 1/8-27 |
| 5FB-2MP | G60291-0502 | 7253-33355 | 1/2-20 | 1/8-27 |
| 6FB-4MP | G60291-0604 | 7253-33345 | 9/16-18 | 1/4-18 |
| 8FB-6MP | G60291-0806 | 7253-33365 | 3/4-16 | 3/8-18 |
| 10FB-8MP | G60291-1008 | 7253-33375 | 7/8-14 | 1/2-14 |
| 12FB-12MP | G60291-1212 | 7253-33385 | 1-1/16-12 | 3/4-14 |
| 16FB-16MP | G60291-1616 | 7253-33395 | 1-5/16-12 | 1-11-1/2 |

| |
|------------------------------|
| EQUIPMENT |
| HOSE/CPLG. SELECTION |
| TECH. DATA |
| EXT. & VERY HIGH PRESS. HOSE |
| GS CPLGS. |
| PCM CPLGS. |
| PCS CPLGS. |
| HIGH & MED. PRESS. HOSE |
| MEGACRIMP® CPLGS. |
| PC CPLGS. |
| FIELD ATTACHABLE CPLGS. |
| AIR BRAKE HOSE & CPLGS. |
| MEGATECH® C5 HOSE & CPLGS. |
| LOW PRESS. HOSE & CPLGS. |
| C14 HOSE & CPLGS. |
| POLARSEAL® HOSE & CPLGS. |
| PWR. STG. HOSE & CPLGS. |
| THERMO-PLASTIC HOSE & CPLGS. |
| ADAPTERS |
| QUICK DISCONNECT CPLGS. |
| ACCESSORIES & ASSORTMENTS |
| PART NUMBER INDEXES |



The World's Most Trusted Name in Belts, Hose and Hydraulics.

www.gates.com

L15

Adapters — SAE to SAE – G60 Series

For use up to SAE 100R2 maximum working pressure.

Male O-Ring Boss to Male JIC 37° Flare

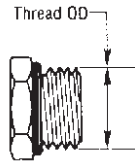

O-Ring Boss Male (MB)

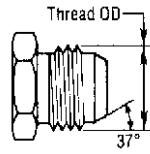

JIC 37° Male (MJ, MJLN)



| |
|------------------------------|
| EQUIPMENT |
| HOSE/CPLG. SELECTION |
| TECH. DATA |
| EXT. & VERY HIGH PRESS. HOSE |
| GS CPLGS. |
| PCM CPLGS. |
| PCS CPLGS. |
| HIGH & MED. PRESS. HOSE |
| MEGACRIMP® CPLGS. |
| PC CPLGS. |
| FIELD ATTACHABLE CPLGS. |
| AIR BRAKE HOSE & CPLGS. |
| MEGATECH™/C5 HOSE & CPLGS. |
| LOW PRESS. HOSE & CPLGS. |
| C14 HOSE & CPLGS. |
| POLARSEAL® HOSE & CPLGS. |
| PWR. STG. HOSE & CPLGS. |
| THERMO-PLASTIC HOSE & CPLGS. |
| ADAPTERS |
| QUICK DISCONNECT CPLGS. |
| ACCESSORIES & ASSORTMENTS |
| PART NUMBER INDEXES |

| Descr | # | | |  | | O-Ring # | | |
|-----------|-------------|-------------|------------|---|-----------|----------|-------------|-----------|
| | | | | MB | MJ | | | |
| 4MB-4MJ | 86884 | G60301-0404 | 7253-86884 | 7/16-20 | 7/16-20 | 82501 | G60248-0004 | 7254-0004 |
| 4MB-6MJ | G60301-0406 | G60301-0406 | 7253-33405 | 7/16-20 | 9/16-18 | 82501 | G60248-0004 | 7254-0004 |
| 5MB-3MJ | 86885 | G60301-0503 | 7253-86885 | 1/2-20 | 3/8-24 | 82502 | G60248-0005 | 7254-0005 |
| 5MB-4MJ | 86886 | G60301-0504 | 7253-86886 | 1/2-20 | 7/16-20 | 82502 | G60248-0005 | 7254-0005 |
| 5MB-5MJ | 86887 | G60301-0505 | 7253-86887 | 1/2-20 | 1/2-20 | 82502 | G60248-0005 | 7254-0005 |
| 5MB-6MJ | G60301-0506 | G60301-0506 | 7253-33415 | 1/2-20 | 9/16-18 | 82502 | G60248-0005 | 7254-0005 |
| 6MB-4MJ | 86888 | G60301-0604 | 7253-86888 | 9/16-18 | 7/16-20 | 82503 | G60248-0006 | 7254-0006 |
| 6MB-6MJ | 86889 | G60301-0606 | 7253-04685 | 9/16-18 | 9/16-18 | 82503 | G60248-0006 | 7254-0006 |
| 6MB-8MJ | 86891 | G60301-0608 | 7253-86891 | 9/16-18 | 3/4-16 | 82503 | G60248-0006 | 7254-0006 |
| 6MB-10MJ | G60301-0610 | G60301-0610 | 7253-33425 | 9/16-18 | 7/8-14 | 82503 | G60248-0006 | 7254-0006 |
| 8MB-6MJ | 86892 | G60301-0806 | 7253-04775 | 3/4-16 | 9/16-18 | 82504 | G60248-0008 | 7254-0008 |
| 8MB-8MJ | 86893 | G60301-0808 | 7253-86893 | 3/4-16 | 3/4-16 | 82504 | G60248-0008 | 7254-0008 |
| 8MB-10MJ | 86894 | G60301-0810 | 7253-86894 | 3/4-16 | 7/8-14 | 82504 | G60248-0008 | 7254-0008 |
| 8MB-12MJ | 86895 | G60301-0812 | 7253-86895 | 3/4-16 | 1-1/16-12 | 82504 | G60248-0008 | 7254-0008 |
| 10MB-6MJ | G60301-1006 | G60301-1006 | 7253-86896 | 7/8-14 | 9/16-18 | 82505 | G60248-0010 | 7254-0010 |
| 10MB-8MJ | 86897 | G60301-1008 | 7253-86897 | 7/8-14 | 3/4-16 | 82505 | G60248-0010 | 7254-0010 |
| 10MB-10MJ | 86898 | G60301-1010 | 7253-86898 | 7/8-14 | 7/8-14 | 82505 | G60248-0010 | 7254-0010 |
| 12MB-8MJ | 86899 | G60301-1208 | 7253-86899 | 1-1/16-12 | 3/4-16 | 82506 | G60248-0012 | 7254-0012 |
| 12MB-10MJ | G60301-1210 | G60301-1210 | 7253-86901 | 1-1/16-12 | 7/8-14 | 82506 | G60248-0012 | 7254-0012 |
| 12MB-12MJ | 86902 | G60301-1212 | 7253-86902 | 1-1/16-12 | 1-1/16-12 | 82506 | G60248-0012 | 7254-0012 |
| 12MB-16MJ | 86903 | G60301-1216 | 7253-86903 | 1-1/16-12 | 1-5/16-12 | 82506 | G60248-0012 | 7254-0012 |
| 16MB-10MJ | 86904 | G60301-1610 | 7253-86904 | 1-5/16-12 | 7/8-14 | 82508 | G60248-0016 | 7254-0006 |
| 16MB-12MJ | 86905 | G60301-1612 | 7253-86905 | 1-5/16-12 | 1-1/16-12 | 82508 | G60248-0016 | 7254-0016 |
| 16MB-16MJ | 86906 | G60301-1616 | 7253-86906 | 1-5/16-12 | 1-5/16-12 | 82508 | G60248-0016 | 7254-0016 |
| 20MB-10MJ | 86907 | G60301-2010 | 7253-86907 | 1-5/8-12 | 7/8-14 | 82509 | G60248-0020 | 7254-0020 |
| 20MB-12MJ | 86908 | G60301-2012 | 7253-86908 | 1-5/8-12 | 1-1/16-12 | 82509 | G60248-0020 | 7254-0020 |
| 20MB-16MJ | 86909 | G60301-2016 | 7253-86909 | 1-5/8-12 | 1-5/16-12 | 82509 | G60248-0020 | 7254-0020 |
| 20MB-20MJ | 86911 | G60301-2020 | 7253-86911 | 1-5/8-12 | 1-5/8-12 | 82509 | G60248-0020 | 7254-0020 |



Adapters — SAE to SAE – G60 Series

For use up to SAE 100R2 maximum working pressure.

Male O-Ring Boss to Male JIC 37° Flare – 45°

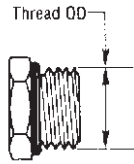

O-Ring Boss Male (MB)

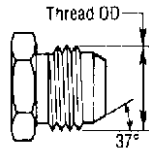

JIC 37° Male (MJ, MJLN)



| Descr | # | | |  | | O-Ring # | | |
|-------------|-------------|-------------|------------|---|-----------|----------|-------------|-----------|
| | | | | MB | MJ | | | |
| 4MB-4MJ45 | 86912 | G60308-0404 | 7253-28565 | 7/16-20 | 7/16-20 | 82501 | G60248-0004 | 7254-0004 |
| 5MB-5MJ45 | 86913 | G60308-0505 | 7253-28575 | 1/2-20 | 1/2-20 | 82502 | G60248-0005 | 7254-0005 |
| 6MB-6MJ45 | 86914 | G60308-0606 | 7253-28585 | 9/16-18 | 9/16-18 | 82503 | G60248-0006 | 7254-0006 |
| 8MB-8MJ45 | 86915 | G60308-0808 | 7253-28255 | 3/4-16 | 3/4-16 | 82504 | G60248-0008 | 7254-0008 |
| 8MB-10MJ45 | G60308-0810 | G60308-0810 | 7253-28415 | 3/4-16 | 7/8-14 | 82504 | G60248-0008 | 7254-0008 |
| 10MB-8MJ45 | G60308-1008 | G60308-1008 | 7253-28425 | 7/8-14 | 3/4-16 | 82505 | G60248-0010 | 7254-0010 |
| 10MB-10MJ45 | 86916 | G60308-1010 | 7253-86916 | 7/8-14 | 7/8-14 | 82505 | G60248-0010 | 7254-0010 |
| 12MB-12MJ45 | 86917 | G60308-1212 | 7253-28595 | 1-1/16-12 | 1-1/16-12 | 82506 | G60248-0012 | 7254-0012 |
| 12MB-16MJ45 | G60308-1216 | G60308-1216 | 7253-28435 | 1-1/16-12 | 1-5/16-12 | 82506 | G60248-0012 | 7254-0012 |
| 14MB-14MJ45 | 86918 | G60308-1414 | 7253-28605 | 1-3/16-12 | 1-3/16-12 | 82507 | G60248-0014 | 7254-0014 |
| 16MB-12MJ45 | G60308-1612 | G60308-1612 | 7253-28445 | 1-5/16-12 | 1-1/16-12 | 82508 | G60248-0016 | 7254-0016 |
| 16MB-16MJ45 | 86919 | G60308-1616 | 7253-28615 | 1-5/16-12 | 1-5/16-12 | 82508 | G60248-0016 | 7254-0016 |

EQUIPMENT

HOSE/CPLG. SELECTION

TECH. DATA

EXT. & VERY HIGH PRESS. HOSE

GS CPLGS.

PCM CPLGS.

PCS CPLGS.

HIGH & MED. PRESS. HOSE

MEGACRIMP® CPLGS.

PC CPLGS.

FIELD ATTACHABLE CPLGS.

AIR BRAKE HOSE & CPLGS.

MEGATECH® C5 HOSE & CPLGS.

LOW PRESS. HOSE & CPLGS.

C14 HOSE & CPLGS.

POLARSEAL® HOSE & CPLGS.

PWR. STG. HOSE & CPLGS.

THERMO-PLASTIC HOSE & CPLGS.

ADAPTERS

QUICK DISCONNECT CPLGS.

ACCESSORIES & ASSORTMENTS

PART NUMBER INDEXES



Adapters — SAE to SAE – G60 Series

For use up to SAE 100R2 maximum working pressure.

Male O-Ring Boss to Male JIC 37° Flare – 90°

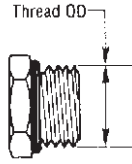

O-Ring Boss Male (MB)

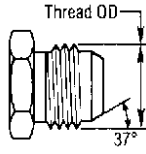

JIC 37° Male (MJ, MJLN)



| |
|------------------------------|
| EQUIPMENT |
| HOSE/CPLG. SELECTION |
| TECH. DATA |
| EXT. & VERY HIGH PRESS. HOSE |
| GS CPLGS. |
| PCM CPLGS. |
| PCS CPLGS. |
| HIGH & MED. PRESS. HOSE |
| MEGACRIMP® CPLGS. |
| PC CPLGS. |
| FIELD ATTACHABLE CPLGS. |
| AIR BRAKE HOSE & CPLGS. |
| MEGATECH™ C5 HOSE & CPLGS. |
| LOW PRESS. HOSE & CPLGS. |
| C14 HOSE & CPLGS. |
| POLARSEAL® HOSE & CPLGS. |
| PWR. STG. HOSE & CPLGS. |
| THERMO-PLASTIC HOSE & CPLGS. |
| ADAPTERS |
| QUICK DISCONNECT CPLGS. |
| ACCESSORIES & ASSORTMENTS |
| PART NUMBER INDEXES |

| Descr | # | | | 🌀 | | O-Ring # | | |
|-------------|-------------|-------------|------------|-----------|-----------|----------|-------------|-----------|
| | | | | MB | MJ | | | |
| 4MB-4MJ90 | 86921 | G60312-0404 | 7253-28265 | 7/16-20 | 7/16-20 | 82501 | G60248-0004 | 7254-0004 |
| 4MB-6MJ90 | G60312-0406 | G60312-0406 | 7253-28455 | 7/16-20 | 9/16-18 | 82501 | G60248-0004 | 7254-0004 |
| 5MB-5MJ90 | 86922 | G60312-0505 | 7253-28625 | 1/2-20 | 1/2-20 | 82502 | G60248-0005 | 7254-0005 |
| 6MB-4MJ90 | G60312-0604 | G60312-0604 | 7253-28465 | 9/16-18 | 7/16-20 | 82503 | G60248-0006 | 7254-0006 |
| 6MB-5MJ90 | G60312-0605 | G60312-0605 | 7253-28475 | 9/16-18 | 1/2-20 | 82503 | G60248-0006 | 7254-0006 |
| 6MB-6MJ90 | 86923 | G60312-0606 | 7253-28275 | 9/16-18 | 9/16-18 | 82503 | G60248-0006 | 7254-0006 |
| 6MB-8MJ90 | G60312-0608 | G60312-0608 | 7253-28485 | 9/16-18 | 3/4-16 | 82503 | G60248-0006 | 7254-0006 |
| 8MB-6MJ90 | G60312-0806 | G60312-0806 | 7253-28505 | 3/4-16 | 9/16-18 | 82504 | G60248-0008 | 7254-0008 |
| 8MB-8MJ90 | 86924 | G60312-0808 | 7253-28285 | 3/4-16 | 3/4-16 | 82504 | G60248-0008 | 7254-0008 |
| 8MB-10MJ90 | G60312-0810 | G60312-0810 | 7253-28515 | 3/4-16 | 7/8-14 | 82504 | G60248-0008 | 7254-0008 |
| 8MB-12MJ90 | G60312-0812 | G60312-0812 | 7253-28525 | 3/4-16 | 1-1/16-12 | 82504 | G60248-0008 | 7254-0008 |
| 10MB-8MJ90 | 86925 | G60312-1008 | 7253-28295 | 7/8-14 | 3/4-16 | 82505 | G60248-0010 | 7254-0010 |
| 10MB-10MJ90 | 86926 | G60312-1010 | 7253-28635 | 7/8-14 | 7/8-14 | 82505 | G60248-0010 | 7254-0010 |
| 10MB-12MJ90 | G60312-1012 | G60312-1012 | 7253-28535 | 7/8-14 | 1-1/16-12 | 82505 | G60248-0010 | 7254-0010 |
| 12MB-10MJ90 | G60312-1210 | G60312-1210 | 7253-28545 | 1-1/16-12 | 7/8-14 | 82506 | G60248-0012 | 7254-0012 |
| 12MB-12MJ90 | 86927 | G60312-1212 | 7253-28645 | 1-1/16-12 | 1-1/16-12 | 82506 | G60248-0012 | 7254-0012 |
| 12MB-16MJ90 | G60312-1216 | G60312-1216 | 7253-28555 | 1-1/16-12 | 1-5/16-12 | 82506 | G60248-0012 | 7254-0012 |
| 14MB-14MJ90 | 86928 | G60312-1414 | 7253-28655 | 1-3/16-12 | 1-3/16-12 | 82507 | G60248-0014 | 7254-0014 |
| 16MB-12MJ90 | G60312-1612 | G60312-1612 | 7253-28315 | 1-5/16-12 | 1-1/16-12 | 82508 | G60248-0016 | 7254-0016 |
| 16MB-16MJ90 | 86929 | G60312-1616 | 7253-28325 | 1-5/16-12 | 1-5/16-12 | 82508 | G60248-0016 | 7254-0016 |



Adapters — SAE to SAE – G60 Series

For use up to SAE 100R2 maximum working pressure.

Male JIC 37° Flare on Run to Male O-Ring Boss – Tee

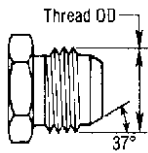

JIC 37° Male (MJ, MJLN)

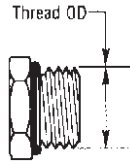

O-Ring Boss Male (MB)



| Descr | # | | 🌀 | | O-Ring # | | |
|----------------|-------------|------------|-----------|-----------|----------|-------------|-----------|
| | | | MJ | MB | | | |
| 4MJ-4MJ-4MB | G60350-0404 | 7253-33615 | 7/16-20 | 7/16-20 | 82501 | G60248-0004 | 7254-0004 |
| 5MJ-5MJ-5MB | G60350-0505 | 7253-33625 | 1/2-20 | 1/2-20 | 82502 | G60248-0005 | 7254-0005 |
| 6MJ-6MJ-6MB | G60350-0606 | 7253-33635 | 9/16-18 | 9/16-18 | 82503 | G60248-0006 | 7254-0006 |
| 8MJ-8MJ-8MB | G60350-0808 | 7253-33645 | 3/4-16 | 3/4-16 | 82504 | G60248-0008 | 7254-0008 |
| 10MJ-10MJ-10MB | G60350-1010 | 7253-33655 | 7/8-14 | 7/8-14 | 82505 | G60248-0010 | 7254-0010 |
| 12MJ-12MJ-12MB | G60350-1212 | 7253-33665 | 1-1/16-12 | 1-1/16-12 | 82506 | G60248-0012 | 7254-0012 |
| 16MJ-16MJ-16MB | G60350-1616 | 7253-33675 | 1-5/16-12 | 1-5/16-12 | 82508 | G60248-0016 | 7254-0016 |

Male O-Ring Boss to Male JIC 37° Flare to Male JIC 37° Flare – Tee

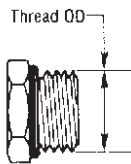

O-Ring Boss Male (MB)

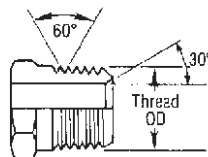

JIC 37° Male (MJ, MJLN)

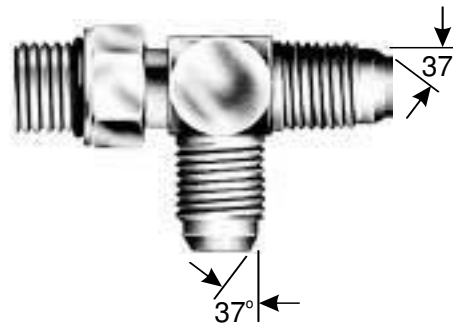

| Descr | # | | 🌀 | | O-Ring # | | |
|----------------|-------------|------------|-----------|-----------|----------|-------------|-----------|
| | | | MB | MJ | | | |
| 4MB-4MJ-4MJ | G60352-0404 | 7253-33685 | 7/16-20 | 7/16-20 | 82501 | G60248-0004 | 7254-0004 |
| 5MB-5MJ-5MJ | G60352-0505 | 7253-33695 | 1/2-20 | 1/2-20 | 82502 | G60248-0005 | 7254-0005 |
| 6MB-6MJ-6MJ | G60352-0606 | 7253-33705 | 9/16-18 | 9/16-18 | 82503 | G60248-0006 | 7254-0006 |
| 8MB-8MJ-8MJ | G60352-0808 | 7253-33715 | 3/4-16 | 3/4-16 | 82504 | G60248-0008 | 7254-0008 |
| 10MB-10MJ-10MJ | G60352-1010 | 7253-33725 | 7/8-14 | 7/8-14 | 82505 | G60248-0010 | 7254-0010 |
| 12MB-12MJ-12MJ | G60352-1212 | 7253-33735 | 1-1/16-12 | 1-1/16-12 | 82506 | G60248-0012 | 7254-0012 |
| 16MB-16MJ-16MJ | G60352-1616 | 7253-33745 | 1-5/16-12 | 1-5/16-12 | 82508 | G60248-0016 | 7254-0016 |

EQUIPMENT

HOSE/CPLG. SELECTION

TECH. DATA

EXT. & VERY HIGH PRESS. HOSE

GS CPLGS.

PCM CPLGS.

PCS CPLGS.

HIGH & MED. PRESS. HOSE

MEGACRIMP® CPLGS.

PC CPLGS.

FIELD ATTACHABLE CPLGS.

AIR BRAKE HOSE & CPLGS.

MEGATECH® C5 HOSE & CPLGS.

LOW PRESS. HOSE & CPLGS.

C14 HOSE & CPLGS.

POLARSEAL® HOSE & CPLGS.

PWR. STG. HOSE & CPLGS.

THERMO-PLASTIC HOSE & CPLGS.

ADAPTERS

QUICK DISCONNECT CPLGS.

ACCESSORIES & ASSORTMENTS

PART NUMBER INDEXES



Adapters — SAE to SAE – G60 Series

For use up to SAE 100R2 maximum working pressure.

Locknut for Bulkhead Adapters



| Descr | # | |  | |
|-------|-------------|------------|---|-------|
| | | | | |
| 4LN | G60399-0004 | 7253-24605 | 7/16-20 | 9/16 |
| 5LN | G60399-0005 | 7253-24615 | 1/2-20 | 5/8 |
| 6LN | G60399-0006 | 7253-24625 | 9/16-18 | 11/16 |
| 8LN | G60399-0008 | 7253-24635 | 3/4-16 | 7/8 |
| 10LN | G60399-0010 | 7253-24645 | 7/8-14 | 1 |
| 12LN | G60399-0012 | 7253-24655 | 1 1/16-12 | 1 1/4 |
| 16LN | G60399-0016 | 7253-24665 | 1 5/16-20 | 1 1/2 |

*Lock nut not included on bulkhead fittings.

Female JIC 37° Flare Cap

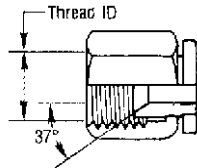

JIC 37° Flare Female (FJX)

| Descr | # | |  | |
|----------|-------------|-------------|---|-----------|
| | | | | |
| 4FJ-CAP | 87510 | G60401-0004 | 7253-24305 | 7/16-20 |
| 5FJ-CAP | 87511 | G60401-0005 | 7253-24315 | 1/2-20 |
| 6FJ-CAP | 87512 | G60401-0006 | 7253-24325 | 9/16-18 |
| 8FJ-CAP | 87513 | G60401-0008 | 7253-24335 | 3/4-16 |
| 10FJ-CAP | 87514 | G60401-0010 | 7253-24345 | 7/8-14 |
| 12FJ-CAP | 87515 | G60401-0012 | 7253-24355 | 1-1/16-12 |
| 16FJ-CAP | 87516 | G60401-0016 | 7253-24365 | 1-5/16-12 |
| 20FJ-CAP | 87517 | G60401-0020 | 7253-24375 | 1-5/8-12 |
| 24FJ-CAP | G60401-0024 | G60401-0024 | 7253-24385 | 1-7/8-12 |
| 32FJ-CAP | G60401-0032 | G60401-0032 | 7253-24405 | 2-1/2-12 |

EQUIPMENT
HOSE/CPLG. SELECTION
TECH. DATA
EXT. & VERY HIGH PRESS. HOSE
GS CPLGS.
PCM CPLGS.
PCS CPLGS.
HIGH & MED. PRESS. HOSE
MEGACRIMP® CPLGS.
PC CPLGS.
FIELD ATTACHABLE CPLGS.
AIR BRAKE HOSE & CPLGS.
MEGATECH™/C5 HOSE & CPLGS.
LOW PRESS. HOSE & CPLGS.
C14 HOSE & CPLGS.
POLARSEAL® HOSE & CPLGS.
PWR. STG. HOSE & CPLGS.
THERMO-PLASTIC HOSE & CPLGS.
ADAPTERS
QUICK DISCONNECT CPLGS.
ACCESSORIES & ASSORTMENTS
PART NUMBER INDEXES

Adapters – SAE to SAE – G60 Series

For use up to SAE 100R2 maximum working pressure.

Male JIC 37° Flare Plug

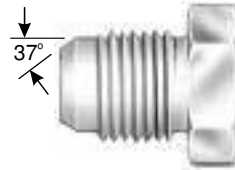
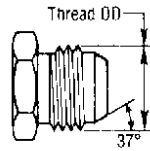

JIC 37° Male (MJ, MJLN)

| Descr | # | |  | |
|-----------|-------------|-------------|---|-----------|
| 4MJ-PLUG | 87740 | G60402-0004 | 7253-22885 | 7/16-20 |
| 5MJ-PLUG | 87741 | G60402-0005 | 7253-22895 | 1/2-20 |
| 6MJ-PLUG | 87742 | G60402-0006 | 7253-22905 | 9/16-18 |
| 8MJ-PLUG | 87743 | G60402-0008 | 7253-22915 | 3/4-16 |
| 10MJ-PLUG | 87744 | G60402-0010 | 7253-22925 | 7/8-14 |
| 12MJ-PLUG | 87745 | G60402-0012 | 7253-22935 | 1-1/16-12 |
| 14MJ-PLUG | 87746 | G60402-0014 | 7253-22945 | 1-3/16-12 |
| 16MJ-PLUG | 87747 | G60402-0016 | 7253-22955 | 1-5/16-12 |
| 20MJ-PLUG | 87748 | G60402-0020 | 7253-22965 | 1-5/8-12 |
| 24MJ-PLUG | G60402-0024 | G60402-0024 | 7253-33755 | 1-7/8-12 |
| 32MJ-PLUG | G60402-0032 | G60402-0032 | 7253-33765 | 2-1/2-12 |

Male JIC 37° Flare to Female Braze-On

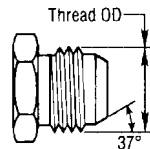

JIC 37° Male (MJ, MJLN)

| Descr | # | |  | B" |
|------------|-------------|------------|---|-------|
| 4MJ-4FBO | G60405-0404 | 7253-28665 | 7/16-20 | 1/4 |
| 6MJ-6FBO | G60405-0606 | 7253-28685 | 9/16-18 | 3/8 |
| 8MJ-8FBO | G60405-0808 | 7253-28695 | 3/4-16 | 1/2 |
| 10MJ-10FBO | G60405-1010 | 7253-28705 | 7/8-14 | 5/8 |
| 12MJ-12FBO | G60405-1212 | 7253-28715 | 1-1/16-12 | 3/4 |
| 16MJ-16FBO | G60405-1616 | 7253-28725 | 1-5/16-12 | 1 |
| 20MJ-20FBO | G60405-2020 | 7253-28735 | 1-5/8-12 | 1-1/4 |
| 24MJ-24FBO | G60405-2424 | 7253-28745 | 1-7/8-12 | 1-1/2 |

- EQUIPMENT
- HOSE/CPLG. SELECTION
- TECH. DATA
- EXT. & VERY HIGH PRESS. HOSE
- GS CPLGS.
- PCM CPLGS.
- PCS CPLGS.
- HIGH & MED. PRESS. HOSE
- MEGACRIMP® CPLGS.
- PC CPLGS.
- FIELD ATTACHABLE CPLGS.
- AIR BRAKE HOSE & CPLGS.
- MEGATECH® C5 HOSE & CPLGS.
- LOW PRESS. HOSE & CPLGS.
- C14 HOSE & CPLGS.
- POLARSEAL® HOSE & CPLGS.
- PWR. STG. HOSE & CPLGS.
- THERMO-PLASTIC HOSE & CPLGS.
- ADAPTERS
- QUICK DISCONNECT CPLGS.
- ACCESSORIES & ASSORTMENTS
- PART NUMBER INDEXES



Adapters — SAE to SAE – G60 Series

For use up to SAE 100R2 maximum working pressure.

Male JIC 37° Flare to Male JIC 37° Flare

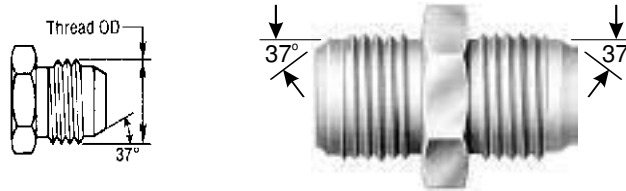

JIC 37° Male (MJ, MJLN)

| Descr | # | | |  | |
|-----------|-------------|-------------|------------|---|-----------|
| | | | | MJ | MJ |
| 4MJ-4MJ | 86701 | G60410-0404 | 7253-86701 | 7/16-20 | 7/16-20 |
| 4MJ-6MJ | G60410-0406 | G60410-0406 | 7253-33785 | 7/16-20 | 9/16-18 |
| 5MJ-5MJ | 86702 | G60410-0505 | 7253-86702 | 1/2-20 | 1/2-20 |
| 6MJ-6MJ | 86703 | G60410-0606 | 7253-06265 | 9/16-18 | 9/16-18 |
| 6MJ-8MJ | G60410-0608 | G60410-0608 | 7253-33805 | 9/16-18 | 3/4-16 |
| 8MJ-8MJ | 86704 | G60410-0808 | 7253-06275 | 3/4-16 | 3/4-16 |
| 8MJ-10MJ | G60410-0810 | G60410-0810 | 7253-33825 | 3/4-16 | 7/8-14 |
| 10MJ-10MJ | 86705 | G60410-1010 | 7253-86705 | 7/8-14 | 7/8-14 |
| 10MJ-12MJ | G60410-1012 | G60410-1012 | 7253-33835 | 7/8-14 | 1-1/16-12 |
| 12MJ-12MJ | 86706 | G60410-1212 | 7253-86706 | 1-1/16-12 | 1-1/16-12 |
| 16MJ-16MJ | 86707 | G60410-1616 | 7253-86707 | 1-5/16-12 | 1-5/16-12 |
| 20MJ-20MJ | 86708 | G60410-2020 | 7253-86708 | 1-5/8-12 | 1-5/8-12 |
| 24MJ-24MJ | G60410-2424 | G60410-2424 | 7253-33845 | 1-7/8-12 | 1-7/8-12 |
| 32MJ-32MJ | G60410-3232 | G60410-3232 | 7253-33855 | 2-1/2-12 | 2-1/2-12 |

Male JIC 37° Flare to Female JIC 37° Flare

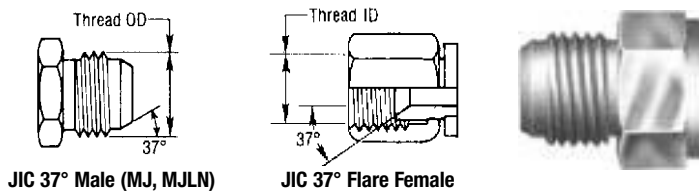

JIC 37° Male (MJ, MJLN)

JIC 37° Flare Female

| Descr | # | |  | |
|-----------|-------------|------------|---|-----------|
| | | | MJ | FJ |
| 4MJ-6FJ | G60420-0406 | 7253-33865 | 7/16-20 | 9/16-18 |
| 6MJ-8FJ | G60420-0608 | 7253-33875 | 9/16-18 | 3/4-16 |
| 6MJ-10FJ | G60420-0610 | 7253-33885 | 9/16-18 | 7/8-14 |
| 8MJ-10FJ | G60420-0810 | 7253-33895 | 3/4-16 | 7/8-14 |
| 8MJ-12FJ | G60420-0812 | 7253-33905 | 3/4-16 | 1-1/16-12 |
| 10MJ-12FJ | G60420-1012 | 7253-33915 | 7/8-14 | 1-1/16-12 |
| 10MJ-16FJ | G60420-1016 | 7253-33925 | 7/8-14 | 1-5/16-12 |
| 12MJ-16FJ | G60420-1216 | 7253-33935 | 1-1/16-12 | 1-5/16-12 |
| 12MJ-20FJ | G60420-1220 | 7253-33945 | 1-1/16-12 | 1-5/8-12 |
| 16MJ-20FJ | G60420-1620 | 7253-33955 | 1-5/16-12 | 1-5/8-12 |

Adapters — SAE to SAE – G60 Series

For use up to SAE 100R2 maximum working pressure.

Male JIC 37° Flare to Female JIC 37° Flare Swivel – 45°

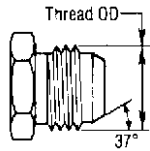

JIC 37° Male (MJ, MJLN)

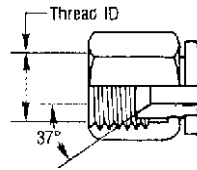

JIC 37° Flare Female (FJX)



| Descr | # | | |  | |
|--------------|-------------|-------------|------------|---|-----------|
| | | | | MJ | FJX |
| 4MJ-4FJX45 | 87730 | G60424-0404 | 7253-23215 | 7/16-20 | 7/16-20 |
| 5MJ-5FJX45 | G60424-0505 | G60424-0505 | 7253-33965 | 1/2-20 | 1/2-20 |
| 6MJ-6FJX45 | 87731 | G60424-0606 | 7253-23225 | 9/16-18 | 9/16-18 |
| 8MJ-8FJX45 | 87732 | G60424-0808 | 7253-23235 | 3/4-16 | 3/4-16 |
| 10MJ-10FJX45 | 87733 | G60424-1010 | 7253-23245 | 7/8-14 | 7/8-14 |
| 12MJ-12FJX45 | 87734 | G60424-1212 | 7253-23255 | 1-1/16-12 | 1-1/16-12 |
| 16MJ-16FJX45 | 87735 | G60424-1616 | 7253-23265 | 1-5/16-12 | 1-5/16-12 |
| 20MJ-20FJX45 | 87736 | G60424-2020 | 7253-23275 | 1-5/8-12 | 1-5/8-12 |

Male JIC 37° Flare to Female JIC 37° Flare Swivel – 90°

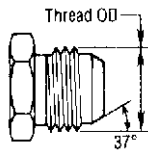

JIC 37° Male (MJ, MJLN)

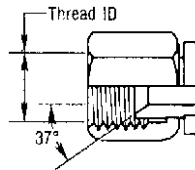

JIC 37° Flare Female (FJX)

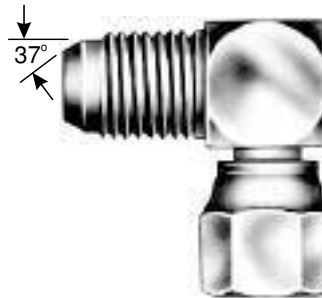

| Descr | # | | |  | |
|--------------|-------------|-------------|------------|---|-----------|
| | | | | MJ | FJX |
| 4MJ-4FJX90 | 87480 | G60422-0404 | 7253-23285 | 7/16-20 | 7/16-20 |
| 5MJ-5FJX90 | G60422-0505 | G60422-0505 | 7253-24025 | 1/2-20 | 1/2-20 |
| 6MJ-6FJX90 | 87481 | G60422-0606 | 7253-23295 | 9/16-18 | 9/16-18 |
| 8MJ-8FJX90 | 87482 | G60422-0808 | 7253-23305 | 3/4-16 | 3/4-16 |
| 10MJ-10FJX90 | 87484 | G60422-1010 | 7253-23315 | 7/8-14 | 7/8-14 |
| 12MJ-12FJX90 | 87485 | G60422-1212 | 7253-23325 | 1-1/16-12 | 1-1/16-12 |
| 16MJ-16FJX90 | 87486 | G60422-1616 | 7253-23335 | 1-5/16-12 | 1-5/16-12 |
| 20MJ-20FJX90 | G60422-2020 | G60422-2020 | 7253-24075 | 1-5/8-12 | 1-5/8-12 |
| 24MJ-24FJX90 | G60422-2424 | G60422-2424 | 7253-24085 | 1-7/8-12 | 1-7/8-12 |
| 32MJ-32FJX90 | G60422-3232 | G60422-3232 | 7253-24095 | 2-1/2-12 | 2-1/2-12 |

EQUIPMENT

HOSE/CPLG. SELECTION

TECH. DATA

EXT. & VERY HIGH PRESS. HOSE

GS CPLGS.

PCM CPLGS.

PCS CPLGS.

HIGH & MED. PRESS. HOSE

MEGACRIMP® CPLGS.

PC CPLGS.

FIELD ATTACHABLE CPLGS.

AIR BRAKE HOSE & CPLGS.

MEGATECH® C5 HOSE & CPLGS.

LOW PRESS. HOSE & CPLGS.

C14 HOSE & CPLGS.

POLARSEAL® HOSE & CPLGS.

PWR. STG. HOSE & CPLGS.

THERMO-PLASTIC HOSE & CPLGS.

ADAPTERS

QUICK DISCONNECT CPLGS.

ACCESSORIES & ASSORTMENTS

PART NUMBER INDEXES



Adapters — SAE to SAE – G60 Series

For use up to SAE 100R2 maximum working pressure.

Male JIC 37° Flare to Male JIC 37° Flare Bulkhead

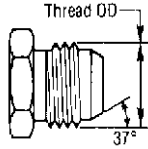

JIC 37° Male (MJ, MJLN)



| Descr | # | | | |
|-------------|-------------|-------------|------------|-----------|
| 4MJ-4BKHD | 87550 | G60445-0404 | 7253-24505 | 7/16-20 |
| 5MJ-5BKHD | 87551 | G60445-0505 | 7253-24515 | 1/2-20 |
| 6MJ-6BKHD | 87552 | G60445-0606 | 7253-24525 | 9/16-18 |
| 8MJ-8BKHD | 87553 | G60445-0808 | 7253-24535 | 3/4-16 |
| 10MJ-10BKHD | 87554 | G60445-1010 | 7253-24545 | 7/8-14 |
| 12MJ-12BKHD | 87555 | G60445-1212 | 7253-24555 | 1-1/16-12 |
| 16MJ-16BKHD | 87556 | G60445-1616 | 7253-24565 | 1-5/16-12 |
| 20MJ-20BKHD | G60445-2020 | G60445-2020 | 7253-34155 | 1-5/8-12 |
| 24MJ-24BKHD | G60445-2424 | G60445-2424 | 7253-34165 | 1-7/8-12 |

Male JIC 37° Flare to Male JIC 37° Flare Bulkhead – 45°

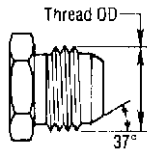

JIC 37° Male (MJ, MJLN)



| Descr | # | | | |
|---------------|-------------|--|------------|-----------|
| 4MJ-4BKHD45 | G60446-0404 | | 7253-34175 | 7/16-20 |
| 5MJ-5BKHD45 | G60446-0505 | | 7253-34185 | 1/2-20 |
| 6MJ-6BKHD45 | G60446-0606 | | 7253-34195 | 9/16-18 |
| 8MJ-8BKHD45 | G60446-0808 | | 7253-34205 | 3/4-16 |
| 10MJ-10BKHD45 | G60446-1010 | | 7253-34215 | 7/8-14 |
| 12MJ-12BKHD45 | G60446-1212 | | 7253-34225 | 1-1/16-12 |
| 16MJ-16BKHD45 | G60446-1616 | | 7253-34235 | 1-5/16-12 |

EQUIPMENT

HOSE/CPLG.
SELECTION

TECH. DATA

EXT. &
VERY HIGH
PRESS. HOSE

GS CPLGS.

PCM CPLGS.

PCS CPLGS.

HIGH & MED.
PRESS. HOSE

MEGACRIMP®
CPLGS.

PC CPLGS.

FIELD
ATTACHABLE
CPLGS.

AIR BRAKE
HOSE &
CPLGS.

MEGATECH™/
C5
HOSE &
CPLGS.

LOW PRESS.
HOSE &
CPLGS.

C14 HOSE
& CPLGS.

POLARSEAL®
HOSE &
CPLGS.

PWR. STG.
HOSE &
CPLGS.

THERMO-
PLASTIC
HOSE &
CPLGS.

ADAPTERS

QUICK
DISCONNECT
CPLGS.

ACCESSORIES
& ASSORT-
MENTS

PART NUMBER
INDEXES

Adapters – SAE to SAE – G60 Series



For use up to SAE 100R2 maximum working pressure.

Male JIC 37° Flare to Male JIC 37° Flare Bulkhead – 90°

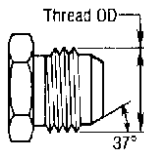

JIC 37° Male (MJ, MJLN)

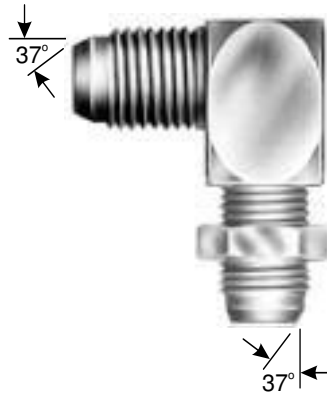

| Descr | # | | |
|---------------|-------------|------------|-----------|
| 4MJ-4BKHD90 | G60447-0404 | 7253-34255 | 7/16-20 |
| 5MJ-5BKHD90 | G60447-0505 | 7253-34265 | 1/2-20 |
| 6MJ-6BKHD90 | G60447-0606 | 7253-34275 | 9/16-18 |
| 8MJ-8BKHD90 | G60447-0808 | 7253-34285 | 3/4-16 |
| 10MJ-10BKHD90 | G60447-1010 | 7253-34295 | 7/8-14 |
| 12MJ-12BKHD90 | G60447-1212 | 7253-34305 | 1-1/16-12 |
| 16MJ-16BKHD90 | G60447-1616 | 7253-34315 | 1-5/16-12 |
| 20MJ-20BKHD90 | G60447-2020 | 7253-34325 | 1-5/8-12 |

Male JIC 37° Flare – Tee

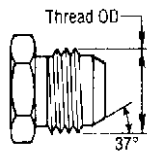

JIC 37° Male (MJ, MJLN)



| Descr | # | | |
|----------------|-------------|-------------|-----------|
| 4MJ-4MJ-4MJ | 87580 | G60469-0404 | 7/16-20 |
| 5MJ-5MJ-5MJ | G60469-0505 | G60469-0505 | 1/2-20 |
| 6MJ-6MJ-6MJ | 87581 | G60469-0606 | 9/16-18 |
| 6MJ-6MJ-8MJ | G60469-0608 | G60469-0608 | 9/16-18 |
| 8MJ-8MJ-8MJ | 87582 | G60469-0808 | 3/4-16 |
| 10MJ-10MJ-10MJ | 87583 | G60469-1010 | 7/8-14 |
| 12MJ-12MJ-12MJ | 87584 | G60469-1212 | 1-1/16-12 |
| 16MJ-16MJ-16MJ | 87585 | G60469-1616 | 1-5/16-12 |
| 20MJ-20MJ-20MJ | 87586 | G60469-2020 | 1-5/8-12 |

EQUIPMENT

HOSE/CPLG. SELECTION

TECH. DATA

EXT. & VERY HIGH PRESS. HOSE

GS CPLGS.

PCM CPLGS.

PCS CPLGS.

HIGH & MED. PRESS. HOSE

MEGACRIMP® CPLGS.

PC CPLGS.

FIELD ATTACHABLE CPLGS.

AIR BRAKE HOSE & CPLGS.

MEGATECH® C5 HOSE & CPLGS.

LOW PRESS. HOSE & CPLGS.

C14 HOSE & CPLGS.

POLARSEAL® HOSE & CPLGS.

PWR. STG. HOSE & CPLGS.

THERMO-PLASTIC HOSE & CPLGS.

ADAPTERS

QUICK DISCONNECT CPLGS.

ACCESSORIES & ASSORTMENTS

PART NUMBER INDEXES



The World's Most Trusted Name in Belts, Hose and Hydraulics.

www.gates.com

L25

Adapters — SAE to SAE – G60 Series

For use up to SAE 100R2 maximum working pressure.

Male JIC 37° Flare on Run to Female JIC 37° Flare Swivel – Tee

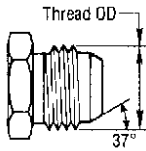

JIC 37° Male (MJ, MJLN)

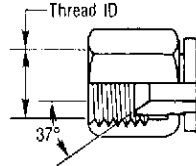

JIC 37° Flare Female (FJX)



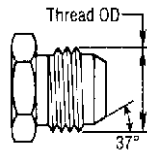

| Descr | # | | |  | |
|-----------------|-------------|-------------|------------|---|-----------|
| | | | | MJ | FJX |
| 4MJ-4MJ-4FJX | 87590 | G60470-0404 | 7253-24805 | 7/16-20 | 7/16-20 |
| 6MJ-6MJ-6FJX | 87591 | G60470-0606 | 7253-24815 | 9/16-18 | 9/16-18 |
| 8MJ-8MJ-8FJX | 87592 | G60470-0808 | 7253-24825 | 3/4-16 | 3/4-16 |
| 10MJ-10MJ-10FJX | G60470-1010 | G60470-1010 | 7253-34405 | 7/8-14 | 7/8-14 |
| 12MJ-12MJ-12FJX | 87593 | G60470-1212 | 7253-24835 | 1-1/16-12 | 1-1/16-12 |
| 16MJ-16MJ-16FJX | 87594 | G60470-1616 | 7253-24845 | 1-5/16-12 | 1-5/16-12 |
| 20MJ-20MJ-20FJX | G60470-2020 | G60470-2020 | 7253-34415 | 1-5/8-12 | 1-5/8-12 |

Male JIC 37° Flare on Run to Male JIC 37° Flare Bulkhead – Tee

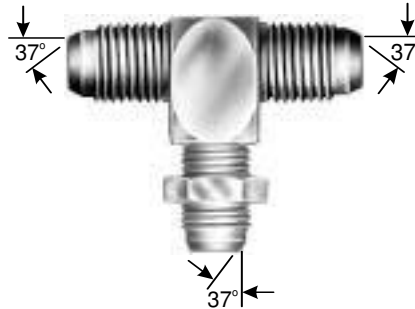

JIC 37° Male (MJ, MJLN)



| Descr | # | |  |
|------------------|-------------|------------|---|
| 4MJ-4MJ-4BKHD | G60471-0404 | 7253-34425 | 7/16-20 |
| 6MJ-6MJ-6BKHD | G60471-0606 | 7253-34445 | 9/16-18 |
| 8MJ-8MJ-8BKHD | G60471-0808 | 7253-34455 | 3/4-16 |
| 10MJ-10MJ-10BKHD | G60471-1010 | 7253-34465 | 7/8-14 |
| 12MJ-12MJ-12BKHD | G60471-1212 | 7253-34475 | 1-1/16-12 |

EQUIPMENT
HOSE/CPLG. SELECTION
TECH. DATA
EXT. & VERY HIGH PRESS. HOSE
GS CPLGS.
PCM CPLGS.
PCS CPLGS.
HIGH & MED. PRESS. HOSE
MEGACRIMP® CPLGS.
PC CPLGS.
FIELD ATTACHABLE CPLGS.
AIR BRAKE HOSE & CPLGS.
MEGATECH™ C5 HOSE & CPLGS.
LOW PRESS. HOSE & CPLGS.
C14 HOSE & CPLGS.
POLARSEAL® HOSE & CPLGS.
PWR. STG. HOSE & CPLGS.
THERMO-PLASTIC HOSE & CPLGS.
ADAPTERS
QUICK DISCONNECT CPLGS.
ACCESSORIES & ASSORTMENTS
PART NUMBER INDEXES

Adapters — SAE to SAE – G60 Series

For use up to SAE 100R2 maximum working pressure.

Male JIC 37° Flare to Male JIC 37° Flare Bulkhead to Male JIC 37° Flare – Tee

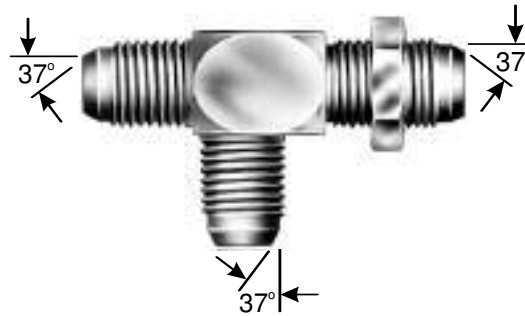
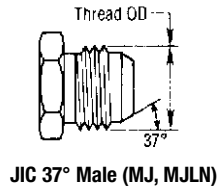

| Descr | # | | | |
|------------------|-------------|--|------------|-----------|
| 4MJ-4BKHD-4MJ | G60472-0404 | | 7253-34495 | 7/16–20 |
| 6MJ-6BKHD-6MJ | G60472-0606 | | 7253-34515 | 9/16–18 |
| 8MJ-8BKHD-8MJ | G60472-0808 | | 7253-34525 | 3/4–16 |
| 10MJ-10BKHD-10MJ | G60472-1010 | | 7253-34535 | 7/8–14 |
| 12MJ-12BKHD-12MJ | G60472-1212 | | 7253-34545 | 1-1/16–12 |
| 16MJ-16BKHD-16MJ | G60472-1616 | | 7253-34555 | 1-5/16–12 |

Male JIC 37° Flare to Female JIC 37° Flare Swivel to Male JIC 37° Flare – Tee

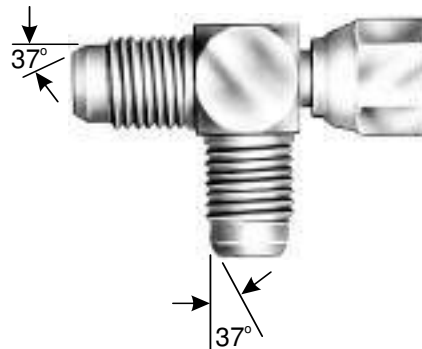
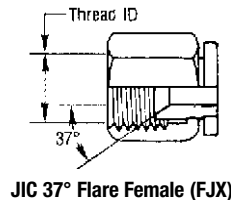
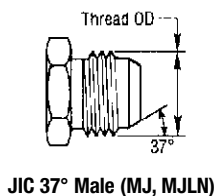

| Descr | # | | | | |
|-----------------|-------|-------------|------------|-----------|-----------|
| | | | | MJ | FJX |
| 4MJ-4FJX-4MJ | 87570 | G60473-0404 | 7253-24705 | 7/16–20 | 7/16–20 |
| 6MJ-6FJX-6MJ | 87572 | G60473-0606 | 7253-24725 | 9/16–18 | 9/16–18 |
| 8MJ-8FJX-8MJ | 87573 | G60473-0808 | 7253-24735 | 3/4–16 | 3/4–16 |
| 10MJ-10FJX-10MJ | 87574 | G60473-1010 | 7253-24745 | 7/8–14 | 7/8–14 |
| 12MJ-12FJX-12MJ | 87575 | G60473-1212 | 7253-24755 | 1-1/16–12 | 1-1/16–12 |
| 16MJ-16FJX-16MJ | 87576 | G60473-1616 | 7253-24765 | 1-5/16–12 | 1-5/16–12 |

EQUIPMENT

HOSE/CPLG. SELECTION

TECH. DATA

EXT. & VERY HIGH PRESS. HOSE

GS CPLGS.

PCM CPLGS.

PCS CPLGS.

HIGH & MED. PRESS. HOSE

MEGACRIMP® CPLGS.

PC CPLGS.

FIELD ATTACHABLE CPLGS.

AIR BRAKE HOSE & CPLGS.

MEGATECH® C5 HOSE & CPLGS.

LOW PRESS. HOSE & CPLGS.

C14 HOSE & CPLGS.

POLARSEAL® HOSE & CPLGS.

PWR. STG. HOSE & CPLGS.

THERMO-PLASTIC HOSE & CPLGS.

ADAPTERS

QUICK DISCONNECT CPLGS.

ACCESSORIES & ASSORTMENTS

PART NUMBER INDEXES



Adapters — SAE to SAE – G60 Series

For use up to SAE 100R2 maximum working pressure.

Male JIC 37° Flare to Male Pipe NPTF

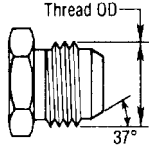

JIC 37° Male (MJ, MJLN)

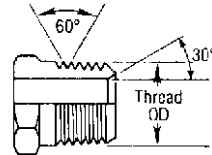

NPTF Solid Male (MP)



| DESCR | # | | |  | |
|-----------|-------------|-------------|------------|---|--------------|
| | | | | MJ | MP (NPTF) |
| 4MJ-2MP | 86711 | G60490-0402 | 7253-86711 | 7/16-20 | 1/8-27 |
| 4MJ-4MP | 86712 | G60490-0404 | 7253-04195 | 7/16-20 | 1/4-18 |
| 4MJ-6MP | 86713 | G60490-0406 | 7253-86713 | 7/16-20 | 3/8-18 |
| 5MJ-2MP | 86714 | G60490-0502 | 7253-86714 | 1/2-20 | 1/8-27 |
| 5MJ-4MP | 86715 | G60490-0504 | 7253-86715 | 1/2-20 | 1/4-18 |
| 5MJ-6MP | 86720 | G60490-0506 | 7253-25665 | 1/2-20 | 3/8-18 |
| 6MJ-2MP | 86716 | G60490-0602 | 7253-86716 | 9/16-18 | 1/8-27 |
| 6MJ-4MP | 86717 | G60490-0604 | 7253-25635 | 9/16-18 | 1/4-18 |
| 6MJ-6MP | 86718 | G60490-0606 | 7253-04225 | 9/16-18 | 3/8-18 |
| 6MJ-8MP | 86719 | G60490-0608 | 7253-86719 | 9/16-18 | 1/2-14 |
| 8MJ-4MP | 86721 | G60490-0804 | 7253-86721 | 3/4-16 | 1/4-18 |
| 8MJ-6MP | 86722 | G60490-0806 | 7253-86722 | 3/4-16 | 3/8-18 |
| 8MJ-8MP | 86723 | G60490-0808 | 7253-04235 | 3/4-16 | 1/2-14 |
| 8MJ-12MP | 86724 | G60490-0812 | 7253-86724 | 3/4-16 | 3/4-14 |
| 10MJ-6MP | 86725 | G60490-1006 | 7253-86725 | 7/8-14 | 3/8-18 |
| 10MJ-8MP | 86726 | G60490-1008 | 7253-25715 | 7/8-14 | 1/2-14 |
| 10MJ-12MP | 86727 | G60490-1012 | 7253-86727 | 7/8-14 | 3/4-14 |
| 12MJ-8MP | 86728 | G60490-1208 | 7253-86728 | 1-1/16-12 | 1/2-14 |
| 12MJ-12MP | 86729 | G60490-1212 | 7253-25735 | 1-1/16-12 | 3/4-14 |
| 12MJ-16MP | 86731 | G60490-1216 | 7253-86731 | 1-1/16-12 | 1-11-1/2 |
| 16MJ-12MP | 86732 | G60490-1612 | 7253-86732 | 1-5/16-12 | 3/4-14 |
| 16MJ-16MP | 86733 | G60490-1616 | 7253-04275 | 1-5/16-12 | 1-11-1/2 |
| 16MJ-20MP | G60490-1620 | G60490-1620 | 7253-34565 | 1-5/16-12 | 1-1/4-11-1/2 |
| 20MJ-16MP | 86734 | G60490-2016 | 7253-86734 | 1-5/8-12 | 1-11-1/2 |
| 20MJ-20MP | 86735 | G60490-2020 | 7253-86735 | 1-5/8-12 | 1-1/4-11-1/2 |
| 20MJ-24MP | G60490-2024 | G60490-2024 | 7253-34575 | 1-5/8-12 | 1-1/2-11-1/2 |
| 24MJ-20MP | G60490-2420 | G60490-2420 | 7253-34585 | 1-7/8-12 | 1-1/4-11-1/2 |
| 24MJ-24MP | 86737 | G60490-2424 | 7253-86737 | 1-7/8-12 | 1-1/2-11-1/2 |
| 32MJ-32MP | 86738 | G60490-3232 | 7253-86738 | 2-1/2-12 | 2-11-1/2 |

ADAPTERS

QUICK DISCONNECT CPLGS.

ACCESSORIES & ASSORTMENTS

PART NUMBER INDEXES



Adapters — SAE to SAE – G60 Series

For use up to SAE 100R2 maximum working pressure.

Male JIC 37° Flare to Male Pipe NPTF – 45°

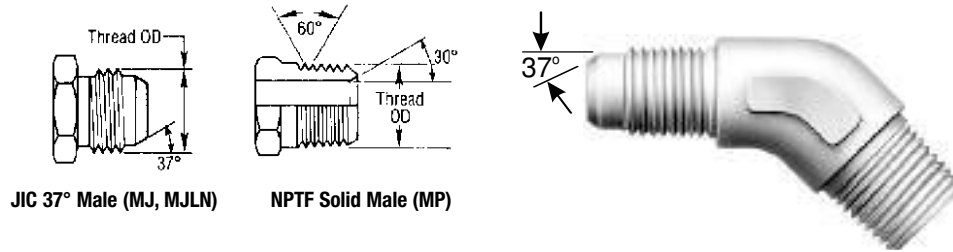

JIC 37° Male (MJ, MJLN)

NPTF Solid Male (MP)

| Descr | # |  | | | |
|-------------|-------------|---|------------|-----------|--------------|
| | | MJ | MP (NPTF) | | |
| 4MJ-2MP45 | 86758 | G60497-0402 | 7253-86758 | 7/16-20 | 1/8-27 |
| 4MJ-4MP45 | 86759 | G60497-0404 | 7253-86759 | 7/16-20 | 1/4-18 |
| 4MJ-6MP45 | G60497-0406 | G60497-0406 | 7253-34605 | 7/16-20 | 3/8-18 |
| 5MJ-2MP45 | 86761 | G60497-0502 | 7253-86761 | 1/2-20 | 1/8-27 |
| 5MJ-4MP45 | 86762 | G60497-0504 | 7253-86762 | 1/2-20 | 1/4-18 |
| 6MJ-4MP45 | 86763 | G60497-0604 | 7253-86763 | 9/16-18 | 1/4-18 |
| 6MJ-6MP45 | 86764 | G60497-0606 | 7253-86764 | 9/16-18 | 3/8-18 |
| 6MJ-8MP45 | 86765 | G60497-0608 | 7253-86765 | 9/16-18 | 1/2-14 |
| 8MJ-6MP45 | 86766 | G60497-0806 | 7253-86766 | 3/4-16 | 3/8-18 |
| 8MJ-8MP45 | 86767 | G60497-0808 | 7253-86767 | 3/4-16 | 1/2-14 |
| 8MJ-12MP45 | 86768 | G60497-0812 | 7253-86768 | 3/4-16 | 3/4-14 |
| 10MJ-6MP45 | 86769 | G60497-1006 | 7253-86769 | 7/8-14 | 3/8-18 |
| 10MJ-8MP45 | 86771 | G60497-1008 | 7253-86771 | 7/8-14 | 1/2-14 |
| 12MJ-8MP45 | 86772 | G60497-1208 | 7253-86772 | 1-1/16-12 | 1/2-14 |
| 12MJ-12MP45 | 86773 | G60497-1212 | 7253-86773 | 11-16-12 | 3/4-14 |
| 16MJ-12MP45 | 86774 | G60497-1612 | 7253-86774 | 1-5/16-12 | 3/4-14 |
| 16MJ-16MP45 | 86775 | G60497-1616 | 7253-86775 | 1-5/16-12 | 1-11-1/2 |
| 20MJ-20MP45 | 86776 | G60497-2020 | 7253-86776 | 1-5/8-12 | 1-1/4-11-1/2 |
| 24MJ-24MP45 | 86777 | G60497-2424 | 7253-86777 | 1-7/8-12 | 1-1/2-11-1/2 |
| 32MJ-32MP45 | 86778 | G60497-3232 | 7253-86778 | 2-1/2-12 | 2-11-1/2 |

EQUIPMENT

HOSE/CPLG. SELECTION

TECH. DATA

EXT. & VERY HIGH PRESS. HOSE

GS CPLGS.

PCM CPLGS.

PCS CPLGS.

HIGH & MED. PRESS. HOSE

MEGACRIMP® CPLGS.

PC CPLGS.

FIELD ATTACHABLE CPLGS.

AIR BRAKE HOSE & CPLGS.

MEGATECH® C5 HOSE & CPLGS.

LOW PRESS. HOSE & CPLGS.

C14 HOSE & CPLGS.

POLARSEAL® HOSE & CPLGS.

PWR. STG. HOSE & CPLGS.

THERMO-PLASTIC HOSE & CPLGS.

ADAPTERS

QUICK DISCONNECT CPLGS.

ACCESSORIES & ASSORTMENTS

PART NUMBER INDEXES



The World's Most Trusted Name in Belts, Hose and Hydraulics.

www.gates.com

L29

Adapters — SAE to SAE – G60 Series

For use up to SAE 100R2 maximum working pressure.

Male JIC 37° Flare to Male Pipe NPTF – 90°

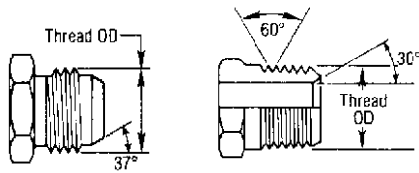

JIC 37° Male (MJ, MJLN)

NPTF Solid Male (MP)

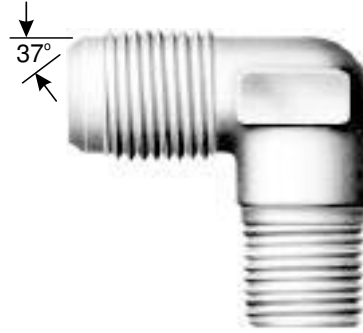

| DESCR | # | | |  | |
|-------------|-------------|-------------|------------|---|--------------|
| | | | | MJ | MP (NPTF) |
| 2MJ-2MP90 | 86779 | G60499-0202 | 7253-86779 | 5/16-24 | 1/8-27 |
| 4MJ-2MP90 | 86781 | G60499-0402 | 7253-86781 | 7/16-20 | 1/8-27 |
| 4MJ-4MP90 | 86782 | G60499-0404 | 7253-86782 | 7/16-20 | 1/4-18 |
| 4MJ-6MP90 | G60499-0406 | G60499-0406 | 7253-34645 | 7/16-20 | 3/8-18 |
| 5MJ-2MP90 | 86783 | G60499-0502 | 7253-86783 | 1/2-20 | 1/8-27 |
| 5MJ-4MP90 | 86784 | G60499-0504 | 7253-86784 | 1/2-20 | 1/4-18 |
| 5MJ-6MP90 | G60499-0506 | G60499-0506 | 7253-34655 | 1/2-20 | 3/8-18 |
| 6MJ-2MP90 | 86785 | G60499-0602 | 7253-86785 | 9/16-18 | 1/8-27 |
| 6MJ-4MP90 | 86786 | G60499-0604 | 7253-28385 | 9/16-18 | 1/4-18 |
| 6MJ-6MP90 | 86787 | G60499-0606 | 7253-28185 | 9/16-18 | 3/8-18 |
| 6MJ-8MP90 | 86788 | G60499-0608 | 7253-86788 | 9/16-18 | 1/2-14 |
| 8MJ-4MP90 | 86789 | G60499-0804 | 7253-86789 | 3/4-16 | 1/4-18 |
| 8MJ-6MP90 | 86791 | G60499-0806 | 7253-86791 | 3/4-16 | 3/8-18 |
| 8MJ-8MP90 | 86792 | G60499-0808 | 7253-28205 | 3/4-16 | 1/2-14 |
| 8MJ-12MP90 | 86793 | G60499-0812 | 7253-86793 | 3/4-16 | 3/4-14 |
| 10MJ-6MP90 | 86794 | G60499-1006 | 7253-86794 | 7/8-14 | 3/8-18 |
| 10MJ-8MP90 | 86795 | G60499-1008 | 7253-28375 | 7/8-14 | 1/2-14 |
| 10MJ-12MP90 | 86796 | G60499-1012 | 7253-86796 | 7/8-14 | 3/4-14 |
| 12MJ-8MP90 | 86797 | G60499-1208 | 7253-86797 | 1-1/16-12 | 1/2-14 |
| 12MJ-12MP90 | 86798 | G60499-1212 | 7253-04475 | 1-1/16-12 | 3/4-14 |
| 12MJ-16MP90 | G60499-1216 | G60499-1216 | 7253-34665 | 1-1/16-12 | 1-11-1/2 |
| 16MJ-12MP90 | 86799 | G60499-1612 | 7253-86799 | 1-5/16-12 | 3/4-14 |
| 16MJ-16MP90 | 86801 | G60499-1616 | 7253-28405 | 1-5/16-12 | 1-11-1/2 |
| 16MJ-20MP90 | G60499-1620 | G60499-1620 | 7253-34675 | 1-5/16-12 | 1-1/4-11-1/2 |
| 20MJ-16MP90 | 86802 | G60499-2016 | 7253-86802 | 1-5/8-12 | 1-11-1/2 |
| 20MJ-20MP90 | 86803 | G60499-2020 | 7253-86803 | 1-5/8-12 | 1-1/4-11-1/2 |
| 20MJ-24MP90 | G60499-2024 | G60499-2024 | 7253-34685 | 1-5/8-12 | 1-1/2-11-1/2 |
| 24MJ-20MP90 | G60499-2420 | G60499-2420 | 7253-34695 | 1-7/8-12 | 1-1/4-11-1/2 |
| 24MJ-24MP90 | 86804 | G60499-2424 | 7253-86804 | 1-7/8-12 | 1-1/2-11-1/2 |
| 32MJ-32MP90 | 86805 | G60499-3232 | 7253-86805 | 2-1/2-12 | 2-11-1/2 |

EQUIPMENT
HOSE/CPLG. SELECTION
TECH. DATA
EXT. & VERY HIGH PRESS. HOSE
GS CPLGS.
PCM CPLGS.
PCS CPLGS.
HIGH & MED. PRESS. HOSE
MEGACRIMP® CPLGS.
PC CPLGS.
FIELD ATTACHABLE CPLGS.
AIR BRAKE HOSE & CPLGS.
MEGATECH® C5 HOSE & CPLGS.
LOW PRESS. HOSE & CPLGS.
C14 HOSE & CPLGS.
POLARSEAL® HOSE & CPLGS.
PWR. STG. HOSE & CPLGS.
THERMO-PLASTIC HOSE & CPLGS.
ADAPTERS
QUICK DISCONNECT CPLGS.
ACCESSORIES & ASSORTMENTS
PART NUMBER INDEXES

Adapters — SAE to SAE – G60 Series

For use up to SAE 100R2 maximum working pressure.

Male JIC 37° Flare to Female Pipe NPTF

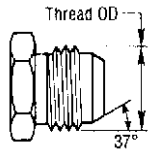

JIC 37° Male (MJ, MJLN)

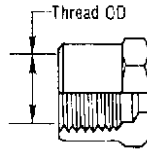

NPTF or NPSF Solid Female (FP)



| Descr | # | | |  | |
|-----------|-------------|-------------|------------|---|--------------|
| | | | | MJ | FP (NPTF) |
| 4MJ-2FP | 86741 | G60510-0402 | 7253-86741 | 7/16-20 | 1/8-27 |
| 4MJ-4FP | 86742 | G60510-0404 | 7253-86742 | 7/16-20 | 1/4-18 |
| 5MJ-2FP | 86743 | G60510-0502 | 7253-86743 | 1/2-20 | 1/8-27 |
| 5MJ-4FP | 86744 | G60510-0504 | 7253-86744 | 1/2-20 | 1/4-18 |
| 6MJ-4FP | 86745 | G60510-0604 | 7253-86745 | 9/16-18 | 1/4-18 |
| 6MJ-6FP | 86746 | G60510-0606 | 7253-86746 | 9/16-18 | 3/8-18 |
| 8MJ-6FP | 86747 | G60510-0806 | 7253-86747 | 3/4-16 | 3/8-18 |
| 8MJ-8FP | 86748 | G60510-0808 | 7253-86748 | 3/4-16 | 1/2-14 |
| 10MJ-6FP | G60510-1006 | G60510-1006 | 7253-34735 | 7/8-14 | 3/8-18 |
| 10MJ-8FP | 86749 | G60510-1008 | 7253-86749 | 7/8-14 | 1/2-14 |
| 12MJ-8FP | G60510-1208 | G60510-1208 | 7253-34755 | 1-1/16-12 | 1/2-14 |
| 12MJ-12FP | 86751 | G60510-1212 | 7253-86751 | 1-1/16-12 | 3/4-14 |
| 16MJ-16FP | 86752 | G60510-1616 | 7253-86752 | 1-5/16-12 | 1-11-1/2 |
| 20MJ-20FP | 86753 | G60510-2020 | 7253-25925 | 1-5/8-12 | 1-1/4-11-1/2 |
| 24MJ-24FP | 86754 | G60510-2424 | 7253-25935 | 1-7/8-12 | 1-1/2-11-1/2 |
| 32MJ-32FP | G60510-3232 | G60510-3232 | 7253-34775 | 2-1/2-12 | 2-11-1/2 |

EQUIPMENT

HOSE/CPLG. SELECTION

TECH. DATA

EXT. & VERY HIGH PRESS. HOSE

GS CPLGS.

PCM CPLGS.

PCS CPLGS.

HIGH & MED. PRESS. HOSE

MEGACRIMP® CPLGS.

PC CPLGS.

FIELD ATTACHABLE CPLGS.

AIR BRAKE HOSE & CPLGS.

MEGATECH® C5 HOSE & CPLGS.

LOW PRESS. HOSE & CPLGS.

C14 HOSE & CPLGS.

POLARSEAL® HOSE & CPLGS.

PWR. STG. HOSE & CPLGS.

THERMO-PLASTIC HOSE & CPLGS.

ADAPTERS

QUICK DISCONNECT CPLGS.

ACCESSORIES & ASSORTMENTS

PART NUMBER INDEXES



The World's Most Trusted Name in Belts, Hose and Hydraulics.

www.gates.com

L31

Adapters — SAE to SAE – G60 Series

For use up to SAE 100R2 maximum working pressure.

Male JIC 37° Flare to Female Pipe NPTF – 90°

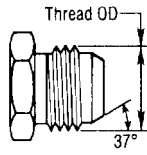

JIC 37° Male (MJ, MJLN)

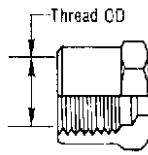

NPTF or NPSF Solid Female (FP)

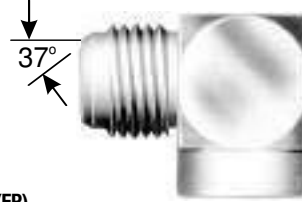

| Descr | # | | |  | |
|-------------|-------------|-------------|------------|---|-----------|
| | | | | MJ | FP (NPTF) |
| 4MJ-2FP90 | 87640 | G60514-0402 | 7253-25105 | 7/16-20 | 1/8-27 |
| 4MJ-4FP90 | G60514-0404 | G60514-0404 | 7253-34785 | 7/16-20 | 1/4-18 |
| 5MJ-4FP90 | G60514-0504 | G60514-0504 | 7253-34805 | 1/2-20 | 1/4-18 |
| 6MJ-4FP90 | 87641 | G60514-0604 | 7253-25115 | 9/16-18 | 1/4-18 |
| 6MJ-6FP90 | G60514-0606 | G60514-0606 | 7253-34825 | 9/16-18 | 3/8-18 |
| 8MJ-6FP90 | 87642 | G60514-0806 | 7253-25125 | 3/4-16 | 3/8-18 |
| 8MJ-8FP90 | G60514-0808 | G60514-0808 | 7253-34835 | 3/4-16 | 1/2-14 |
| 10MJ-8FP90 | 87643 | G60514-1008 | 7253-25135 | 7/8-14 | 1/2-14 |
| 12MJ-12FP90 | 87644 | G60514-1212 | 7253-25145 | 1-1/16-12 | 3/4-14 |
| 16MJ-16FP90 | 87645 | G60514-1616 | 7253-25155 | 1-5/16-12 | 1-11-1/2 |

Female JIC 37° Flare Swivel to Male Pipe NPTF

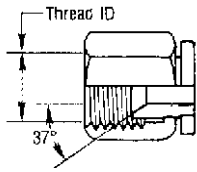

JIC 37° Flare Female (FJX)

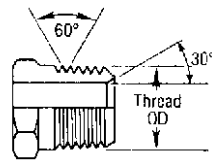

NPTF Solid Male (MP)



| Descr | # | |  | |
|------------|-------------|------------|---|--------------|
| | | | FJX | MP (NPTF) |
| 4FJX-2MP | G60520-0402 | 7253-34865 | 7/16-20 | 1/8-27 |
| 4FJX-4MP | G60520-0404 | 7253-34875 | 7/16-20 | 1/4-18 |
| 6FJX-4MP | G60520-0604 | 7253-34885 | 9/16-18 | 1/4-18 |
| 6FJX-6MP | G60520-0606 | 7253-34895 | 9/16-18 | 3/8-18 |
| 8FJX-6MP | G60520-0806 | 7253-34905 | 3/4-16 | 3/8-18 |
| 8FJX-8MP | G60520-0808 | 7253-34915 | 3/4-16 | 1/2-14 |
| 12FJX-12MP | G60520-1212 | 7253-34925 | 1-1/16-12 | 3/4-14 |
| 16FJX-16MP | G60520-1616 | 7253-34935 | 1-5/16-12 | 1-11-1/2 |
| 20FJX-20MP | G60520-2020 | 7253-34945 | 1-5/8-12 | 1-1/4-11-1/2 |

Adapters — SAE to SAE – G60 Series

For use up to SAE 100R2 maximum working pressure.

Female JIC 37° Flare Swivel to Male Pipe NPTF – 90°

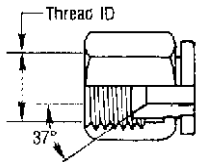

JIC 37° Flare Female (FJX)

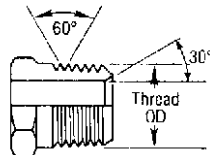

NPTF Solid Male (MP)



| Descr | # | |  | |
|--------------|-------------|------------|---|--------------|
| | | | FJX | MP (NPTF) |
| 4FJX-2MP90 | G60524-0402 | 7253-34955 | 7/16–20 | 1/8–27 |
| 6FJX-4MP90 | G60524-0604 | 7253-34965 | 9/16–18 | 1/4–18 |
| 6FJX-6MP90 | G60524-0606 | 7253-34975 | 9/16–18 | 3/8–18 |
| 8FJX-6MP90 | G60524-0806 | 7253-34985 | 3/4–16 | 3/8–18 |
| 8FJX-8MP90 | G60524-0808 | 7253-34995 | 3/4–16 | 1/2–14 |
| 10FJX-8MP90 | G60524-1008 | 7253-35015 | 7/8–14 | 1/2–14 |
| 12FJX-12MP90 | G60524-1212 | 7253-35025 | 1-1/16–12 | 3/4–14 |
| 16FJX-16MP90 | G60524-1616 | 7253-35285 | 1-5/16–12 | 1–11-1/2 |
| 24FJX-24MP90 | G60524-2424 | 7253-35035 | 1-7/8–12 | 1-1/2–11-1/2 |

Female JIC 37° Flare Swivel to Female Pipe NPTF

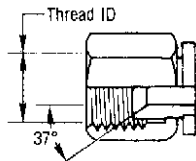

JIC 37° Flare Female (FJX)

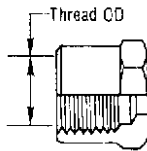

NPTF or NPSF Solid Female (FP)



| Descr | # | |  | |
|------------|-------------|------------|---|--------------|
| | | | FJX | FP (NPTF) |
| 4FJX-2FP | G60530-0402 | 7253-35045 | 7/16–20 | 1/8–27 |
| 4FJX-4FP | G60530-0404 | 7253-35055 | 7/16–20 | 1/4–18 |
| 6FJX-6FP | G60530-0606 | 7253-35075 | 9/16–18 | 3/8–18 |
| 8FJX-6FP | G60530-0806 | 7253-35095 | 3/4–16 | 3/8–18 |
| 8FJX-8FP | G60530-0808 | 7253-35105 | 3/4–16 | 1/2–14 |
| 10FJX-8FP | G60530-1008 | 7253-35115 | 7/8–14 | 1/2–14 |
| 12FJX-12FP | G60530-1212 | 7253-35125 | 1-1/16–12 | 3/4–14 |
| 16FJX-16FP | G60530-1616 | 7253-35135 | 1-5/16–12 | 1–11-1/2 |
| 20FJX-20FP | G60530-2020 | 7253-35145 | 1-5/8–12 | 1-1/4–11-1/2 |

EQUIPMENT

HOSE/CPLG. SELECTION

TECH. DATA

EXT. & VERY HIGH PRESS. HOSE

GS CPLGS.

PCM CPLGS.

PCS CPLGS.

HIGH & MED. PRESS. HOSE

MEGACRIMP® CPLGS.

PC CPLGS.

FIELD ATTACHABLE CPLGS.

AIR BRAKE HOSE & CPLGS.

MEGATECH® C5 HOSE & CPLGS.

LOW PRESS. HOSE & CPLGS.

C14 HOSE & CPLGS.

POLARSEAL® HOSE & CPLGS.

PWR. STG. HOSE & CPLGS.

THERMO-PLASTIC HOSE & CPLGS.

ADAPTERS

QUICK DISCONNECT CPLGS.

ACCESSORIES & ASSORTMENTS

PART NUMBER INDEXES



The World's Most Trusted Name in Belts, Hose and Hydraulics.

www.gates.com

L33

Adapters — SAE to SAE – G60 Series

For use up to SAE 100R2 maximum working pressure.

Male JIC 37° Flare Bulkhead to Male Pipe NPTF

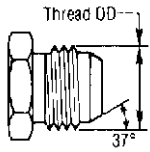

JIC 37° Male (MJ, MJLN)

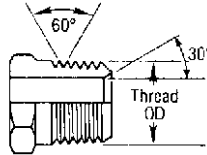

NPTF Solid Male (MP)



| Descr | # | | |  | |
|---------------|-------------|------------|-----------|---|-----------|
| | | | | MJ | MP (NPTF) |
| 4MJBKHD-4MP | G60541-0404 | 7253-35155 | 7/16-20 | 1/4-18 | |
| 6MJBKHD-4MP | G60541-0604 | 7253-35165 | 9/16-18 | 1/4-18 | |
| 8MJBKHD-6MP | G60541-0806 | 7253-35175 | 3/4-16 | 3/8-18 | |
| 10MJBKHD-8MP | G60541-1008 | 7253-35185 | 7/8-14 | 1/2-14 | |
| 12MJBKHD-12MP | G60541-1212 | 7253-35195 | 1-1/16-12 | 3/4-14 | |
| 16MJBKHD-16MP | G60541-1616 | 7253-35205 | 1-5/16-12 | 1-11-1/2 | |

Male JIC 37° Flare on Run to Male Pipe NPTF – Tee

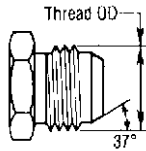

JIC 37° Male (MJ, MJLN)

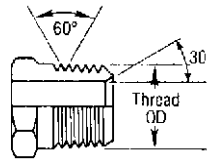

NPTF Solid Male (MP)



| Descr | # | | |  | |
|----------------|-------------|-------------|------------|---|--------------|
| | | | | MJ | MP (NPTF) |
| 4MJ-4MJ-2MP | 87600 | G60551-0402 | 7253-23415 | 7/16-20 | 1/8-27 |
| 4MJ-4MJ-4MP | G60551-0404 | G60551-0404 | 7253-35215 | 7/16-20 | 1/4-18 |
| 5MJ-5MJ-4MP | G60551-0504 | G60551-0504 | 7253-35225 | 1/2-20 | 1/4-18 |
| 6MJ-6MJ-4MP | 87601 | G60551-0604 | 7253-23425 | 9/16-18 | 1/4-18 |
| 6MJ-6MJ-6MP | G60551-0606 | G60551-0606 | 7253-35235 | 9/16-18 | 3/8-18 |
| 6MJ-6MJ-8MP | G60551-0608 | G60551-0608 | 7253-35245 | 9/16-18 | 1/2-14 |
| 8MJ-8MJ-6MP | 87602 | G60551-0806 | 7253-23435 | 3/4-16 | 3/8-18 |
| 8MJ-8MJ-8MP | G60551-0808 | G60551-0808 | 7253-35255 | 3/4-16 | 1/2-14 |
| 10MJ-10MJ-8MP | 87603 | G60551-1008 | 7253-23445 | 7/8-14 | 1/2-14 |
| 12MJ-12MJ-12MP | 87604 | G60551-1212 | 7253-23455 | 1-1/16-12 | 3/4-14 |
| 16MJ-16MJ-16MP | 87605 | G60551-1616 | 7253-23465 | 1-5/16-12 | 1-11-1/2 |
| 20MJ-20MJ-20MP | G60551-2020 | G60551-2020 | 7253-35265 | 1-5/8-12 | 1-1/4-11-1/2 |

EQUIPMENT
HOSE/CPLG. SELECTION
TECH. DATA
EXT. & VERY HIGH PRESS. HOSE
GS CPLGS.
PCM CPLGS.
PCS CPLGS.
HIGH & MED. PRESS. HOSE
MEGACRIMP® CPLGS.
PC CPLGS.
FIELD ATTACHABLE CPLGS.
AIR BRAKE HOSE & CPLGS.
MEGATECH®/C5 HOSE & CPLGS.
LOW PRESS. HOSE & CPLGS.
C14 HOSE & CPLGS.
POLARSEAL® HOSE & CPLGS.
PWR. STG. HOSE & CPLGS.
THERMO-PLASTIC HOSE & CPLGS.
ADAPTERS
QUICK DISCONNECT CPLGS.
ACCESSORIES & ASSORTMENTS
PART NUMBER INDEXES



Adapters — SAE to SAE (Brass) – G60 Series

For use up to SAE 100R5 maximum working pressure.
 Note: Gates does not recommend mixing metal types in any application.

Female Pipe Cap – Brass*

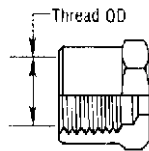

NPTF or NPSF Solid Female (FP)

| Descr | # | | |
|-----------|-------------|------------|--------|
| 2FPB-CAP | G60600-0002 | 7253-66255 | 1/8-27 |
| 4FPB-CAP | G60600-0004 | 7253-66265 | 1/4-18 |
| 6FPB-CAP | G60600-0006 | 7253-66275 | 3/8-18 |
| 8FPB-CAP | G60600-0008 | 7253-66285 | 1/2-14 |
| 12FPB-CAP | G60600-0012 | 7253-66295 | 3/4-14 |

Male Pipe NPTF Plug – Brass*

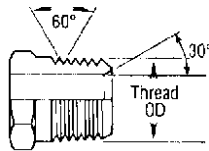

NPTF Solid Male (MP)

| Descr | # | | |
|------------|-------------|------------|--------|
| 2MPB-PLUG | G60601-0002 | 7253-66305 | 1/8-27 |
| 4MPB-PLUG | G60601-0004 | 7253-66315 | 1/4-18 |
| 6MPB-PLUG | G60601-0006 | 7253-66325 | 3/8-18 |
| 8MPB-PLUG | G60601-0008 | 7253-66335 | 1/2-14 |
| 12MPB-PLUG | G60601-0012 | 7253-66345 | 3/4-14 |

- EQUIPMENT
- HOSE/CPLG. SELECTION
- TECH. DATA
- EXT. & VERY HIGH PRESS. HOSE
- GS CPLGS.
- PCM CPLGS.
- PCS CPLGS.
- HIGH & MED. PRESS. HOSE
- MEGACRIMP® CPLGS.
- PC CPLGS.
- FIELD ATTACHABLE CPLGS.
- AIR BRAKE HOSE & CPLGS.
- MEGATECH™ C5 HOSE & CPLGS.
- LOW PRESS. HOSE & CPLGS.
- C14 HOSE & CPLGS.
- POLARSEAL® HOSE & CPLGS.
- PWR. STG. HOSE & CPLGS.
- THERMO-PLASTIC HOSE & CPLGS.
- ADAPTERS
- QUICK DISCONNECT CPLGS.
- ACCESSORIES & ASSORTMENTS
- PART NUMBER INDEXES

* Brass Grade CA 380.



Adapters — SAE to SAE (Brass) – G60 Series

For use up to SAE 100R5 maximum working pressure.
 Note: Gates does not recommend mixing metal types in any application.

Male Pipe NPTF to Male Pipe NPTF – Brass*

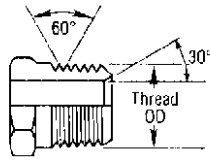

NPTF Solid Male (MP)

| Descr | # | |  | |
|------------|-------------|------------|---|-----------|
| | | | MP (NPTF) | MP (NPTF) |
| 2MP-2MPB | G60605-0202 | 7253-66355 | 1/8-27 | 1/8-27 |
| 2MP-4MPB | G60605-0204 | 7253-66365 | 1/8-27 | 1/4-18 |
| 2MP-6MPB | G60605-0206 | 7253-66375 | 1/8-27 | 3/8-18 |
| 4MP-4MPB | G60605-0404 | 7253-66385 | 1/4-18 | 1/4-18 |
| 4MP-6MPB | G60605-0406 | 7253-66395 | 1/8-27 | 3/8-18 |
| 4MP-8MPB | G60605-0408 | 7253-66405 | 3/8-18 | 1/2-14 |
| 6MP-6MPB | G60605-0606 | 7253-66415 | 3/8-18 | 3/8-18 |
| 6MP-8MPB | G60605-0608 | 7253-66425 | 1/8-27 | 1/2-14 |
| 8MP-8MPB | G60605-0808 | 7253-66435 | 1/2-14 | 1/2-14 |
| 8MP-12MPB | G60605-0812 | 7253-66445 | 1/2-14 | 3/4-14 |
| 12MP-12MPB | G60605-1212 | 7253-66455 | 3/4-14 | 3/4-14 |

Male Pipe NPTF to Male Pipe NPTF – Brass* – 90°

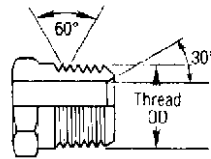

NPTF Solid Male (MP)

| Descr | # | |  | |
|------------|-------------|------------|---|-----------|
| | | | MP (NPTF) | MP (NPTF) |
| 2MP-2MPB90 | G60610-0202 | 7253-66515 | 1/8-27 | 1/8-27 |
| 2MP-4MPB90 | G60610-0204 | 7253-66525 | 1/8-27 | 1/4-18 |
| 2MP-6MPB90 | G60610-0206 | 7253-66535 | 1/8-27 | 3/8-18 |
| 4MP-4MPB90 | G60610-0404 | 7253-66545 | 1/4-18 | 1/4-18 |
| 4MP-6MPB90 | G60610-0406 | 7253-66555 | 1/4-18 | 1/4-18 |
| 6MP-6MPB90 | G60610-0606 | 7253-66565 | 3/8-18 | 3/8-18 |
| 6MP-8MPB90 | G60610-0608 | 7253-66575 | 3/8-18 | 3/8-18 |
| 8MP-8MPB90 | G60610-0808 | 7253-66585 | 1/2-14 | 1/2-14 |

* Brass Grade CA 380.

Adapters – SAE to SAE (Brass) – G60 Series

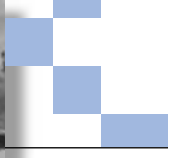

For use up to SAE 100R5 maximum working pressure.
 Note: Gates does not recommend mixing metal types in any application.

Male Pipe NPTF – Brass* – Tee

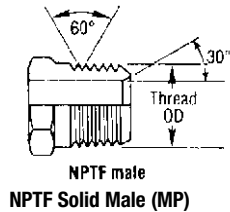

| Descr | # | | MP (NPTF) | |
|-----------------|-------------|------------|-----------|--|
| | | | | |
| 2MP-2MP-2MPB | G60612-0202 | 7253-66595 | 1/8-27 | |
| 4MP-4MP-4MPB | G60612-0404 | 7253-66605 | 1/4-18 | |
| 6MP-6MP-6MPB | G60612-0606 | 7253-66615 | 3/8-18 | |
| 8MP-8MP-8MPB | G60612-0808 | 7253-66625 | 1/2-14 | |
| 12MP-12MP-12MPB | G60612-1212 | 7253-66635 | 3/4-14 | |

Male Pipe NPTF to Female Pipe NPTF – Brass*

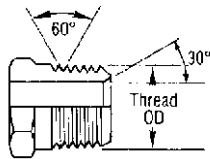

NPTF Solid Male (MP)

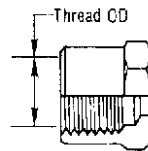

NPTF or NPSF Solid Female (FP)



| Descr | # | | MP (NPTF) | | FP (NPTF) | |
|------------|-------------|------------|-----------|--|-----------|--|
| | | | | | | |
| 2MP-2FPB | G60615-0202 | 7253-66645 | 1/8-27 | | 1/8-27 | |
| 2MP-4FPB | G60615-0204 | 7253-66655 | 1/8-27 | | 1/4-18 | |
| 2MP-6FPB | G60615-0206 | 7253-66665 | 1/8-27 | | 3/8-18 | |
| 4MP-2FPB | G60614-0402 | 7253-66675 | 1/4-18 | | 1/8-27 | |
| 4MP-4FPB | G60615-0404 | 7253-66685 | 1/4-18 | | 1/4-18 | |
| 4MP-6FPB | G60615-0406 | 7253-66695 | 1/4-18 | | 3/8-18 | |
| 4MP-8FPB | G60615-0408 | 7253-66705 | 1/4-18 | | 1/2-14 | |
| 6MP-2FPB | G60614-0602 | 7253-66715 | 3/8-18 | | 1/8-27 | |
| 6MP-4FPB | G60614-0604 | 7253-66725 | 3/8-18 | | 1/4-18 | |
| 6MP-6FPB | G60615-0606 | 7253-66735 | 3/8-18 | | 3/8-18 | |
| 6MP-8FPB | G60615-0608 | 7253-66745 | 3/8-18 | | 1/2-14 | |
| 8MP-2FPB | G60614-0802 | 7253-66755 | 1/2-14 | | 1/4-18 | |
| 8MP-4FPB | G60614-0804 | 7253-66765 | 1/2-14 | | 1/8-27 | |
| 8MP-6FPB | G60614-0806 | 7253-66775 | 1/2-14 | | 3/8-18 | |
| 8MP-8FPB | G60615-0808 | 7253-66785 | 1/2-14 | | 1/2-14 | |
| 8MP-12FPB | G60615-0812 | 7253-66795 | 1/2-14 | | 3/4-14 | |
| 12MP-6FPB | G60614-1206 | 7253-66805 | 3/4-14 | | 3/8-18 | |
| 12MP-8FPB | G60614-1208 | 7253-66815 | 3/4-14 | | 1/2-14 | |
| 12MP-12FPB | G60615-1212 | 7253-66825 | 3/4-14 | | 3/4-14 | |

* Brass Grade CA 380.



The World's Most Trusted Name in Belts, Hose and Hydraulics.

www.gates.com

L37

EQUIPMENT

HOSE/CPLG. SELECTION

TECH. DATA

EXT. & VERY HIGH PRESS. HOSE

GS CPLGS.

PCM CPLGS.

PCS CPLGS.

HIGH & MED. PRESS. HOSE

MEGACRIMP® CPLGS.

PC CPLGS.

FIELD ATTACHABLE CPLGS.

AIR BRAKE HOSE & CPLGS.

MEGATECH® C5 HOSE & CPLGS.

LOW PRESS. HOSE & CPLGS.

C14 HOSE & CPLGS.

POLARSEAL® HOSE & CPLGS.

PWR. STG. HOSE & CPLGS.

THERMO-PLASTIC HOSE & CPLGS.

ADAPTERS

QUICK DISCONNECT CPLGS.

ACCESSORIES & ASSORTMENTS

PART NUMBER INDEXES

Adapters — SAE to SAE (Brass) – G60 Series

For use up to SAE 100R5 maximum working pressure.

Note: Gates does not recommend mixing metal types in any application.

Male Pipe NPTF to Female Pipe NPTF – Brass* – 90°

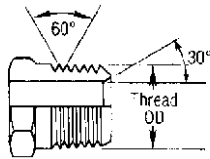

NPTF Solid Male (MP)

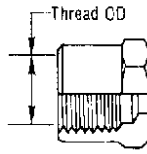

NPTF or NPSF Solid Female (FP)



| Descr | # | |  | |
|--------------|-------------|------------|---|-----------|
| | | | MP (NPTF) | FP (NPTF) |
| 2MP-2FPB90 | G60620-0202 | 7253-66835 | 1/8-27 | 1/8-27 |
| 2MP-4FPB90 | G60620-0204 | 7253-66845 | 1/8-27 | 1/4-18 |
| 4MP-2FPB90 | G60620-0402 | 7253-66855 | 1/4-18 | 1/8-27 |
| 4MP-4FPB90 | G60620-0404 | 7253-66865 | 1/4-18 | 1/4-18 |
| 4MP-6FPB90 | G60620-0406 | 7253-66875 | 1/4-18 | 3/8-18 |
| 6MP-4FPB90 | G60620-0604 | 7253-66885 | 3/8-18 | 1/4-18 |
| 6MP-6FPB90 | G60620-0606 | 7253-66895 | 3/8-18 | 3/8-18 |
| 6MP-8FPB90 | G60620-0608 | 7253-66905 | 3/8-18 | 1/2-14 |
| 8MP-6FPB90 | G60620-0806 | 7253-66915 | 1/2-14 | 3/8-18 |
| 8MP-8FPB90 | G60620-0808 | 7253-66925 | 1/2-14 | 1/2-14 |
| 12MP-12FPB90 | G60620-1212 | 7253-66935 | 3/4-14 | 3/4-14 |

Male Pipe NPTF to Female Inverted – Brass*

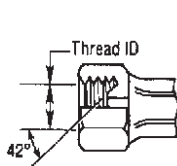

SAE Inverted Flare Solid Female

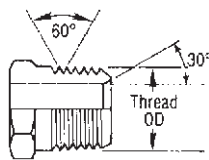

NPTF Solid Male (MP)



| Descr | # | |  | |
|----------|-------------|------------|---|-----------|
| | | | FI | MP (NPTF) |
| 2MP-2FI | G60625-0202 | 7253-69075 | 5/16-28 | 1/8-27 |
| 2MP-3FI | G60625-0203 | 7253-69085 | 3/8-24 | 1/8-27 |
| 2MP-4FI | G60625-0204 | 7253-69095 | 7/16-24 | 1/8-27 |
| 4MP-4FI | G60625-0404 | 7253-69105 | 7/16-24 | 1/4-18 |
| 2MP-5FI | G60625-0205 | 7253-69115 | 1/2-20 | 1/8-27 |
| 4MP-5FI | G60625-0405 | 7253-69125 | 1/2-20 | 1/4-18 |
| 2MP-6FI | G60625-0206 | 7253-69135 | 5/8-18 | 1/8-27 |
| 4MP-6FI | G60625-0406 | 7253-69145 | 5/8-18 | 1/4-18 |
| 6MP-6FI | G60625-0606 | 7253-69155 | 5/8-18 | 3/8-18 |
| 4MP-8FI | G60525-0408 | 7253-69165 | 3/4-18 | 1/4-18 |
| 6MP-8FI | G60625-0608 | 7253-69175 | 3/4-18 | 3/8-18 |
| 8MP-8FI | G60625-0808 | 7253-69185 | 3/4-18 | 1/2-14 |
| 8MP-10FI | G60625-0810 | 7253-69195 | 7/8-18 | 1/2-14 |

* Brass Grade CA 380.

Adapters — SAE to SAE (Brass) – G60 Series

For use up to SAE 100R5 maximum working pressure.
 Note: Gates does not recommend mixing metal types in any application.

Female Pipe NPTF to Female Inverted – Brass*

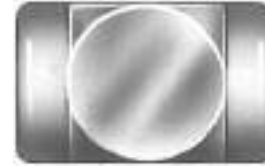
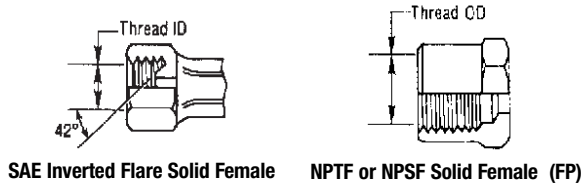

| Descr | # | |  | |
|----------|-------------|------------|---|-----------|
| | | | FI (NPTF) | FP (NPTF) |
| 2FP-3FI | G60630-0203 | 7253-69205 | 3/8-24 | 1/8-27 |
| 2FP-4FI | G60630-0204 | 7253-69215 | 7/16-24 | 1/8-27 |
| 4FP-4FI | G60630-0404 | 7253-69225 | 7/16-24 | 1/4-18 |
| 2FP-5FI | G60630-0205 | 7253-69235 | 1/2-20 | 1/8-27 |
| 4FP-6FI | G60630-0406 | 7253-69245 | 5/8-18 | 1/4-18 |
| 6FP-8FI | G60630-0608 | 7253-69255 | 3/4-18 | 3/8-18 |
| 8FP-10FI | G60630-0810 | 7253-69265 | 7/8-18 | 1/2-14 |

Female Pipe NPTF to Female Pipe NPTF – Brass*

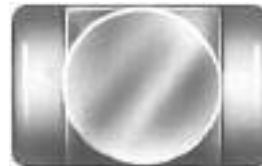
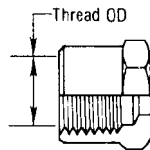

NPTF or NPSF Solid Female (FP)

| Descr | # | |  | |
|------------|-------------|------------|---|-----------|
| | | | FP (NPTF) | FP (NPTF) |
| 2FP-2FPB | G60631-0202 | 7253-66945 | 1/8-27 | 1/8-27 |
| 4FP-2FPB | G60631-0402 | 7253-66955 | 1/4-18 | 1/8-27 |
| 4FP-4FPB | G60631-0404 | 7253-66965 | 1/4-18 | 1/4-18 |
| 6FP-2FPB | G60631-0602 | 7253-66975 | 3/8-18 | 1/8-27 |
| 6FP-4FPB | G60631-0604 | 7253-66985 | 3/8-18 | 1/4-18 |
| 6FP-6FPB | G60631-0606 | 7253-66995 | 3/8-18 | 3/8-18 |
| 8FP-6FPB | G60631-0806 | 7253-67005 | 1/2-14 | 3/8-18 |
| 8FP-8FPB | G60631-0808 | 7253-67015 | 1/2-14 | 1/2-14 |
| 12FP-8FPB | G60631-1208 | 7253-67025 | 3/4-14 | 1/2-14 |
| 12FP-12FPB | G60631-1212 | 7253-67035 | 3/4-14 | 3/4-14 |

* Brass Grade CA 380.



- EQUIPMENT
- HOSE/CPLG. SELECTION
- TECH. DATA
- EXT. & VERY HIGH PRESS. HOSE
- GS CPLGS.
- PCM CPLGS.
- PCS CPLGS.
- HIGH & MED. PRESS. HOSE
- MEGACRIMP® CPLGS.
- PC CPLGS.
- FIELD ATTACHABLE CPLGS.
- AIR BRAKE HOSE & CPLGS.
- MEGATECH® C5 HOSE & CPLGS.
- LOW PRESS. HOSE & CPLGS.
- C14 HOSE & CPLGS.
- POLARSEAL® HOSE & CPLGS.
- PWR. STG. HOSE & CPLGS.
- THERMO-PLASTIC HOSE & CPLGS.
- ADAPTERS
- QUICK DISCONNECT CPLGS.
- ACCESSORIES & ASSORTMENTS
- PART NUMBER INDEXES

Adapters — SAE to SAE (Brass) – G60 Series

For use up to SAE 100R5 maximum working pressure.
 Note: Gates does not recommend mixing metal types in any application.

Female Pipe NPTF to Female Pipe Swivel NPSM – Brass*

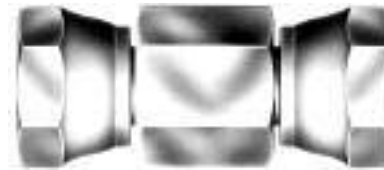
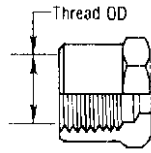

NPTF or NPSF Solid Female (FP)

| Descr | # | |  |
|-------------|-------------|------------|---|
| 2FP-2FPXB | G60632-0202 | 7253-67045 | 1/8-27 |
| 4FP-4FPXB | G60632-0404 | 7253-67055 | 1/4-18 |
| 6FP-6FPXB | G60632-0606 | 7253-67065 | 3/8-18 |
| 8FP-8FPXB | G60632-0808 | 7253-67075 | 1/2-14 |
| 12FP-12FPXB | G60632-1212 | 7253-67085 | 3/4-14 |

Female Pipe NPTF to Female Pipe NPTF – Brass* – 45°

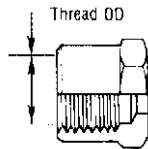

NPTF or NPSF Solid Female (FP)

| Descr | # | |  |
|--------------|-------------|------------|---|
| | | | FP (NPTF) |
| 2FP-2FPB45 | G60635-0202 | 7253-66465 | 1/8-27 |
| 4FP-4FPB45 | G60635-0404 | 7253-66475 | 1/4-18 |
| 6FP-6FPB45 | G60635-0606 | 7253-66485 | 3/8-18 |
| 8FP-8FPB45 | G60635-0808 | 7253-66495 | 1/2-14 |
| 12FP-12FPB45 | G60635-1212 | 7253-66505 | 3/4-14 |

* Brass Grade CA 380.

Adapters — SAE to SAE (Brass) – G60 Series

For use up to SAE 100R5 maximum working pressure.
 Note: Gates does not recommend mixing metal types in any application.

Female Pipe NPTF to Female Pipe NPTF – Brass* – 90°

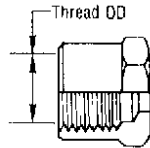

NPTF or NPSF Solid Female (FP)



| Descr | # | |  | |
|--------------|-------------|------------|---|-----------|
| | | | FP (NPTF) | FP (NPTF) |
| 2FP-2FPB90 | G60637-0202 | 7253-67095 | 1/8-27 | 1/8-27 |
| 2FP-4FPB90 | G60637-0204 | 7253-67105 | 1/8-27 | 1/4-18 |
| 4FP-4FPB90 | G60637-0404 | 7253-67115 | 1/4-18 | 1/4-18 |
| 4FP-6FPB90 | G60637-0406 | 7253-67125 | 1/4-18 | 3/8-18 |
| 6FP-6FPB90 | G60637-0606 | 7253-67135 | 3/8-18 | 3/8-18 |
| 6FP-8FPB90 | G60637-0608 | 7253-67145 | 3/8-18 | 1/2-14 |
| 8FP-8FPB90 | G60637-0808 | 7253-67155 | 1/2-14 | 1/2-14 |
| 12FP-12FPB90 | G60637-1212 | 7253-67165 | 3/4-14 | 3/4-14 |

Female Pipe NPTF – Brass* – Tee

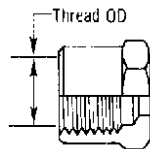

NPTF or NPSF Solid Female (FP)



| Descr | # | |  | |
|-----------------|-------------|------------|---|-----------|
| | | | FP (NPTF) | FP (NPTF) |
| 2FP-2FP-2FPB | G60640-0202 | 7253-67175 | 1/8-27 | 1/8-27 |
| 2FP-2FP-4FPB | G60640-0204 | 7253-67185 | 1/8-27 | 1/4-18 |
| 4FP-4FP-2FPB | G60640-0402 | 7253-67195 | 1/4-18 | 1/8-27 |
| 4FP-4FP-4FPB | G60640-0404 | 7253-67205 | 1/4-18 | 1/4-18 |
| 6FP-6FP-4FPB | G60640-0604 | 7253-67215 | 3/8-18 | 1/4-18 |
| 6FP-6FP-6FPB | G60640-0606 | 7253-67225 | 3/8-18 | 3/8-18 |
| 8FP-8FP-6FPB | G60640-0806 | 7253-67235 | 1/2-14 | 3/8-18 |
| 8FP-8FP-8FPB | G60640-0808 | 7253-67245 | 1/2-14 | 1/2-14 |
| 12FP-12FP-8FPB | G60640-1208 | 7253-67255 | 3/4-14 | 1/2-14 |
| 12FP-12FP-12FPB | G60640-1212 | 7253-67265 | 3/4-14 | 3/4-14 |

* Brass Grade CA 380.



The World's Most Trusted Name in Belts, Hose and Hydraulics.

www.gates.com

L41

EQUIPMENT
 HOSE/CPLG. SELECTION
 TECH. DATA
 EXT. & VERY HIGH PRESS. HOSE
 GS CPLGS.
 PCM CPLGS.
 PCS CPLGS.
 HIGH & MED. PRESS. HOSE
 MEGACRIMP® CPLGS.
 PC CPLGS.
 FIELD ATTACHABLE CPLGS.
 AIR BRAKE HOSE & CPLGS.
 MEGATECH® C5 HOSE & CPLGS.
 LOW PRESS. HOSE & CPLGS.
 C14 HOSE & CPLGS.
 POLARSEAL® HOSE & CPLGS.
 PWR. STG. HOSE & CPLGS.
 THERMO-PLASTIC HOSE & CPLGS.
ADAPTERS
 QUICK DISCONNECT CPLGS.
 ACCESSORIES & ASSORTMENTS
 PART NUMBER INDEXES

Adapters — SAE to SAE (Brass) – G60 Series

For use up to SAE 100R5 maximum working pressure.
 Note: Gates does not recommend mixing metal types in any application.

Female Pipe NPTF to Male Pipe NPTF to Female Pipe NPTF – Brass*

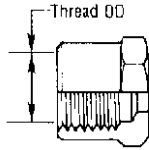

NPTF or NPSF Solid Female (FP)

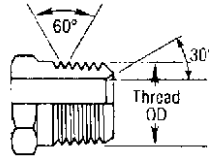

NPTF Solid Male (MP)



| Descr | # | |  | |
|-----------------|-------------|------------|---|-----------|
| | | | FP (NPTF) | MP (NPTF) |
| 2FP-2MP-2FPB | G60641-0202 | 7253-67275 | 1/8-27 | 1/8-27 |
| 4FP-4MP-4FPB | G60641-0404 | 7253-67285 | 1/4-18 | 1/4-18 |
| 6FP-6MP-6FPB | G60641-0606 | 7253-67295 | 3/8-18 | 3/8-18 |
| 8FP-8MP-8FPB | G60641-0808 | 7253-67305 | 1/2-14 | 1/2-14 |
| 12FP-12MP-12FPB | G60641-1212 | 7253-67315 | 3/4-14 | 3/4-14 |

Female Pipe NPTF on Run to Male Pipe NPTF – Brass* - Tee

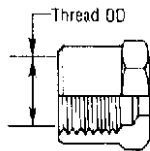

NPTF or NPSF Solid Female (FP)

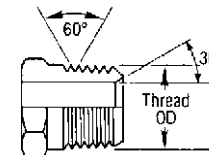

NPTF Solid Male (MP)



| Descr | # | |  | |
|-----------------|-------------|------------|---|-----------|
| | | | FP (NPTF) | MP (NPTF) |
| 2FP-2FP-2MPB | G60642-0202 | 7253-67325 | 1/8-27 | 1/8-27 |
| 4FP-4FP-4MPB | G60642-0404 | 7253-67335 | 1/4-18 | 1/4-18 |
| 6FP-6FP-6MPB | G60642-0606 | 7253-67345 | 3/8-18 | 3/8-18 |
| 8FP-8FP-8MPB | G60642-0808 | 7253-67355 | 1/2-14 | 1/2-14 |
| 12FP-12FP-12MPB | G60642-1212 | 7253-67365 | 3/4-14 | 3/4-14 |

EQUIPMENT
 HOSE/CPLG. SELECTION
 TECH. DATA
 EXT. & VERY HIGH PRESS. HOSE
 GS CPLGS.
 PCM CPLGS.
 PCS CPLGS.
 HIGH & MED. PRESS. HOSE
 MEGACRIMP® CPLGS.
 PC CPLGS.
 FIELD ATTACHABLE CPLGS.
 AIR BRAKE HOSE & CPLGS.
 MEGATECH™/C5 HOSE & CPLGS.
 LOW PRESS. HOSE & CPLGS.
 C14 HOSE & CPLGS.
 POLARSEAL® HOSE & CPLGS.
 PWR. STG. HOSE & CPLGS.
 THERMO-PLASTIC HOSE & CPLGS.
 ADAPTERS
 QUICK DISCONNECT CPLGS.
 ACCESSORIES & ASSORTMENTS
 PART NUMBER INDEXES

* Brass Grade CA 380.



Adapters — SAE to SAE (Brass) — G60 Series

For use up to SAE 100R5 maximum working pressure.
 Note: Gates does not recommend mixing metal types in any application.

Female SAE 45° Flare Cap — Brass*

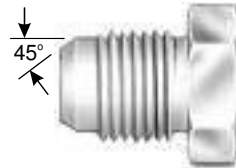
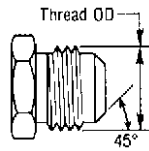

SAE 45° Flare Male (MS)

| Descr | # | |  |
|----------|-------------|------------|---|
| 3FS-CAP | G60643-0003 | 7253-67375 | 3/8-24 |
| 4FS-CAP | G60643-0004 | 7253-67385 | 7/16-20 |
| 5FS-CAP | G60643-0005 | 7253-67395 | 1/2-20 |
| 6FS-CAP | G60643-0006 | 7253-67405 | 5/8-18 |
| 8FS-CAP | G60643-0008 | 7253-67415 | 1 1/16-24 |
| 10FS-CAP | G60643-0010 | 7253-67425 | 7/8-14 |
| 12FS-CAP | G60643-0012 | 7253-67435 | 1 1/16-14 |

Male SAE Plug — Brass*



| Descr | # |  |
|-----------|-------------|---|
| 3MS-PLUG | G60644-0003 | 7253-67445 |
| 4MS-PLUG | G60644-0004 | 7253-67455 |
| 5MS-PLUG | G60644-0005 | 7253-67465 |
| 6MS-PLUG | G60644-0006 | 7253-67475 |
| 8MS-PLUG | G60644-0008 | 7253-67485 |
| 10MS-PLUG | G60644-0010 | 7253-67495 |
| 12MS-PLUG | G60644-0012 | 7253-67505 |

| |
|------------------------------|
| EQUIPMENT |
| HOSE/CPLG. SELECTION |
| TECH. DATA |
| EXT. & VERY HIGH PRESS. HOSE |
| GS CPLGS. |
| PCM CPLGS. |
| PCS CPLGS. |
| HIGH & MED. PRESS. HOSE |
| MEGACRIMP® CPLGS. |
| PC CPLGS. |
| FIELD ATTACHABLE CPLGS. |
| AIR BRAKE HOSE & CPLGS. |
| MEGATECH® C5 HOSE & CPLGS. |
| LOW PRESS. HOSE & CPLGS. |
| C14 HOSE & CPLGS. |
| POLARSEAL® HOSE & CPLGS. |
| PWR. STG. HOSE & CPLGS. |
| THERMO-PLASTIC HOSE & CPLGS. |
| ADAPTERS |
| QUICK DISCONNECT CPLGS. |
| ACCESSORIES & ASSORTMENTS |
| PART NUMBER INDEXES |

* Brass Grade CA 380.



Adapters — SAE to SAE (Brass) – G60 Series

For use up to SAE 100R5 maximum working pressure.
 Note: Gates does not recommend mixing metal types in any application.

Male SAE 45° Flare to Male SAE 45° Flare — Brass*

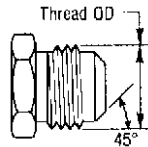

SAE 45° Flare Male (MS)



| Descr | # | | MS | |
|-----------|-------------|------------|-----------|-----------|
| | | | MS | MS |
| 2MS-2MS | G60645-0202 | 7253-67515 | 5/16-24 | 5/16-24 |
| 3MS-3MS | G60645-0303 | 7253-67525 | 3/8-24 | 3/8-24 |
| 4MS-3MS | G60645-0403 | 7253-67535 | 7/16-20 | 3/8-24 |
| 4MS-4MS | G60645-0404 | 7253-67545 | 7/16-20 | 7/16-20 |
| 5MS-4MS | G60645-0504 | 7253-67555 | 1/2-20 | 7/16-20 |
| 5MS-5MS | G60645-0505 | 7253-67565 | 1/2-20 | 1/2-20 |
| 6MS-4MS | G60645-0604 | 7253-67575 | 5/8-18 | 7/16-20 |
| 6MS-5MS | G60645-0605 | 7253-67585 | 5/8-18 | 1/2-20 |
| 6MS-6MS | G60645-0606 | 7253-67595 | 5/8-18 | 5/8-18 |
| 8MS-4MS | G60645-0804 | 7253-67605 | 3/4-16 | 7/16-20 |
| 8MS-6MS | G60645-0806 | 7253-67615 | 3/4-16 | 5/8-18 |
| 8MS-8MS | G60645-0808 | 7253-67625 | 3/4-16 | 3/4-16 |
| 10MS-6MS | G60645-1006 | 7253-67635 | 7/8-14 | 5/8-18 |
| 10MS-8MS | G60645-1008 | 7253-67645 | 7/8-14 | 3/4-16 |
| 10MS-10MS | G60645-1010 | 7253-67655 | 7/8-14 | 7/8-14 |
| 12MS-8MS | G60645-1208 | 7253-67665 | 1 1/16-14 | 7/8-16 |
| 12MS-10MS | G60645-1210 | 7253-67675 | 1 1/16-14 | 7/8-14 |
| 12MS-12MS | G60645-1212 | 7253-67685 | 1 1/16-14 | 1 1/16-14 |

Male SAE 45° Flare to Male SAE 45° Flare – Brass*– 90°

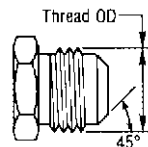

SAE 45° Flare Male (MS)

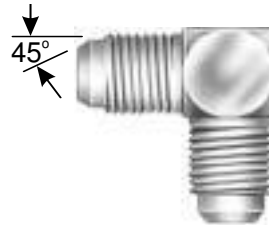

| Descr | # | | MS | |
|-------------|-------------|------------|-----------|-----------|
| | | | MS | MS |
| 2MS-2MS90 | G60648-0202 | 7253-67695 | 5/16-24 | 5/16-24 |
| 4MS-4MS90 | G60648-0404 | 7253-67705 | 7/16-20 | 7/16-20 |
| 5MS-5MS90 | G60648-0505 | 7253-67715 | 1/2-20 | 1/2-20 |
| 6MS-4MS90 | G60648-0604 | 7253-67725 | 5/8-18 | 7/16-20 |
| 6MS-5MS90 | G60648-0605 | 7253-67735 | 5/8-18 | 1/2-20 |
| 6MS-6MS90 | G60648-0606 | 7253-67745 | 5/8-18 | 5/8-18 |
| 8MS-4MS90 | G60648-0804 | 7253-67755 | 3/4-16 | 7/16-20 |
| 8MS-6MS90 | G60648-0806 | 7253-67765 | 3/4-16 | 5/8-18 |
| 8MS-8MS90 | G60648-0808 | 7253-67775 | 3/4-16 | 3/4-16 |
| 10MS-6MS90 | G60648-1006 | 7253-67785 | 7/8-14 | 5/8-18 |
| 10MS-8MS90 | G60648-1008 | 7253-67795 | 7/8-14 | 3/4-16 |
| 10MS-10MS90 | G60648-1010 | 7253-67805 | 7/8-14 | 7/8-14 |
| 12MS-8MS90 | G60648-1208 | 7253-67815 | 1 1/16-14 | 3/4-16 |
| 12MS-10MS90 | G60648-1210 | 7253-67825 | 1 1/16-14 | 7/8-14 |
| 12MS-12MS90 | G60648-1212 | 7253-67835 | 1 1/16-14 | 1 1/16-14 |

* Brass Grade CA 380.



Adapters — SAE to SAE (Brass) — G60 Series

For use up to SAE 100R5 maximum working pressure.
 Note: Gates does not recommend mixing metal types in any application.

Male SAE 45° Flare to Male Pipe NPTF — Brass*

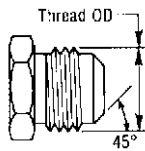

SAE 45° Flare Male (MS)

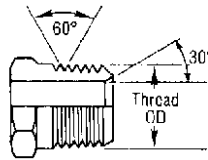

NPTF Solid Male (MP)



| Descr | # | | |  | |
|-----------|-------------|-------------|------------|---|-----------|
| | | | | MS | MP (NPTF) |
| 2MS-2MP | G60650-0202 | G60650-0202 | 7253-67845 | 1/8-27 | 1/8-27 |
| 3MS-2MP | G60650-0302 | G60650-0302 | 7253-67855 | 3/8-24 | 1/8-27 |
| 4MS-2MP | 86808 | G60650-0402 | 7253-86808 | 7/16-20 | 1/8-27 |
| 4MS-4MP | 86809 | G60650-0404 | 7253-86809 | 7/16-20 | 1/4-18 |
| 4MS-6MP | 86811 | G60650-0406 | 7253-86811 | 7/16-20 | 3/8-18 |
| 4MS-8MP | 86790 | G60650-0408 | 7253-26115 | 7/16-20 | 1/2-14 |
| 5MS-2MP | 86800 | G60650-0502 | 7253-26015 | 1/2-20 | 1/8-27 |
| 5MS-4MP | 86812 | G60650-0504 | 7253-86812 | 1/2-20 | 1/4-18 |
| 5MS-6MP | 86810 | G60650-0506 | 7253-26075 | 1/2-20 | 3/8-18 |
| 6MS-2MP | 86820 | G60650-0602 | 7253-26025 | 5/8-18 | 1/8-27 |
| 6MS-4MP | 86813 | G60650-0604 | 7253-86813 | 5/8-18 | 1/4-18 |
| 6MS-6MP | 86814 | G60650-0606 | 7253-86814 | 5/8-18 | 3/8-18 |
| 6MS-8MP | 86815 | G60650-0608 | 7253-86815 | 5/8-18 | 1/2-14 |
| 8MS-4MP | G60650-0804 | G60650-0804 | 7253-67865 | 3/4-16 | 1/4-18 |
| 8MS-6MP | 86817 | G60650-0806 | 7253-86817 | 3/4-16 | 3/8-18 |
| 8MS-8MP | 86818 | G60650-0808 | 7253-86818 | 3/4-16 | 1/2-14 |
| 8MS-12MP | 86825 | G60650-0812 | 7253-26155 | 3/4-16 | 3/4-14 |
| 10MS-6MP | 86830 | G60650-1006 | 7253-26105 | 7/8-14 | 3/8-18 |
| 10MS-8MP | 86819 | G60650-1008 | 7253-86819 | 7/8-14 | 1/2-14 |
| 10MS-12MP | 86821 | G60650-1012 | 7253-86821 | 7/8-14 | 3/4-14 |
| 12MS-8MP | 86822 | G60650-1208 | 7253-86822 | 1-1/16-14 | 1/2-14 |
| 12MS-12MP | 86823 | G60650-1212 | 7253-86823 | 1-1/16-14 | 3/4-14 |

* Brass Grade CA 380.



- EQUIPMENT
- HOSE/CPLG. SELECTION
- TECH. DATA
- EXT. & VERY HIGH PRESS. HOSE
- GS CPLGS.
- PCM CPLGS.
- PCS CPLGS.
- HIGH & MED. PRESS. HOSE
- MEGACRIMP® CPLGS.
- PC CPLGS.
- FIELD ATTACHABLE CPLGS.
- AIR BRAKE HOSE & CPLGS.
- MEGATECH®/C5 HOSE & CPLGS.
- LOW PRESS. HOSE & CPLGS.
- C14 HOSE & CPLGS.
- POLARSEAL® HOSE & CPLGS.
- PWR. STG. HOSE & CPLGS.
- THERMO-PLASTIC HOSE & CPLGS.
- ADAPTERS
- QUICK DISCONNECT CPLGS.
- ACCESSORIES & ASSORTMENTS
- PART NUMBER INDEXES

Adapters — SAE to SAE (Brass) – G60 Series

For use up to SAE 100R5 maximum working pressure.

Note: Gates does not recommend mixing metal types in any application.

Male SAE 45° Flare to Male Pipe NPTF – Brass* – 45°

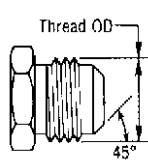

SAE 45° Flare Male (MS)

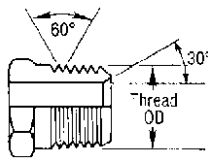

NPTF Solid Male (MP)



| Descr | # | |  | |
|-------------|-------------|------------|---|-----------|
| | | | MS | MP (NPTF) |
| 4MS-2MP45 | G60652-0402 | 7253-67875 | 7/16-20 | 1/8-27 |
| 4MS-4MP45 | G60652-0404 | 7253-67885 | 7/16-20 | 7/16-20 |
| 5MS-2MP45 | G60652-0502 | 7253-67895 | 1/2-20 | 1/8-27 |
| 5MS-4MP45 | G60652-0504 | 7253-67905 | 1/2-20 | 7/16-18 |
| 6MS-4MP45 | G60652-0604 | 7253-67915 | 5/8-18 | 7/16-18 |
| 6MS-6MP45 | G60652-0606 | 7253-67925 | 5/8-18 | 5/8-18 |
| 6MS-8MP45 | G60652-0608 | 7253-67935 | 5/8-18 | 3/4-16 |
| 8MS-6MP45 | G60652-0806 | 7253-67945 | 3/4-16 | 5/8-18 |
| 8MS-8MP45 | G60652-0808 | 7253-67955 | 3/4-16 | 3/4-16 |
| 10MS-8MP45 | G60652-1008 | 7253-67965 | 7/8-14 | 3/4-16 |
| 12MS-8MP45 | G60652-1208 | 7253-67975 | 1 1/16-14 | 3/4-16 |
| 12MS-12MP45 | G60652-1212 | 7253-67985 | 1 1/16-14 | 1 1/16-14 |

EQUIPMENT
HOSE/CPLG. SELECTION
TECH. DATA
EXT. & VERY HIGH PRESS. HOSE
GS CPLGS.
PCM CPLGS.
PCS CPLGS.
HIGH & MED. PRESS. HOSE
MEGACRIMP® CPLGS.
PC CPLGS.
FIELD ATTACHABLE CPLGS.
AIR BRAKE HOSE & CPLGS.
MEGATECH™ C5 HOSE & CPLGS.
LOW PRESS. HOSE & CPLGS.
C14 HOSE & CPLGS.
POLARSEAL® HOSE & CPLGS.
PWR. STG. HOSE & CPLGS.
THERMO-PLASTIC HOSE & CPLGS.
ADAPTERS
QUICK DISCONNECT CPLGS.
ACCESSORIES & ASSORTMENTS
PART NUMBER INDEXES

* Brass Grade CA 380.



Adapters — SAE to SAE (Brass) — G60 Series

For use up to SAE 100R5 maximum working pressure.
 Note: Gates does not recommend mixing metal types in any application.

Male SAE 45° Flare to Male Pipe NPTF — Brass* — 90°

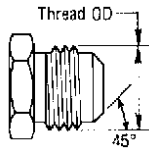

SAE 45° Flare Male (MS)

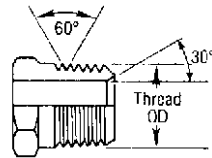

NPTF Solid Male (MP)

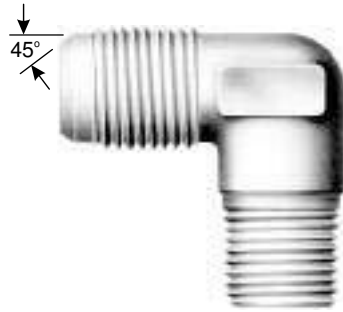

| Descr | # | | |  | |
|-------------|-------------|-------------|------------|---|-----------|
| | | | | MS | MP (NPTF) |
| 2MS-2MP90 | G60654-0202 | G60654-0202 | 7253-67995 | 1/8-27 | 1/8-27 |
| 3MS-2MP90 | G60654-0302 | G60654-0302 | 7253-68005 | 3/8-24 | 1/8-27 |
| 4MS-2MP90 | 86836 | G60654-0402 | 7253-86836 | 7/16-20 | 1/8-27 |
| 4MS-4MP90 | 86837 | G60654-0404 | 7253-86837 | 7/16-20 | 1/4-18 |
| 4MS-6MP90 | 86840 | G60654-0406 | 7253-26675 | 7/16-20 | 3/8-18 |
| 5MS-2MP90 | 86849 | G60654-0502 | 7253-26615 | 1/2-20 | 1/8-27 |
| 5MS-4MP90 | 86838 | G60654-0504 | 7253-86838 | 1/2-20 | 1/4-18 |
| 5MS-6MP90 | G60654-0506 | G60654-0506 | 7253-68015 | 1/2-20 | 5/8-18 |
| 6MS-2MP90 | 86851 | G60654-0602 | 7253-26625 | 5/8-18 | 1/8-27 |
| 6MS-4MP90 | 86839 | G60654-0604 | 7253-86839 | 5/8-18 | 1/4-18 |
| 6MS-6MP90 | 86841 | G60654-0606 | 7253-86841 | 5/8-18 | 3/8-18 |
| 6MS-8MP90 | 86842 | G60654-0608 | 7253-86842 | 5/8-18 | 1/2-14 |
| 6MS-12MP90 | 86852 | G60654-0612 | 7253-26765 | 5/8-18 | 3/4-14 |
| 8MS-4MP90 | 86853 | G60654-0804 | 7253-26665 | 3/4-16 | 1/4-18 |
| 8MS-6MP90 | 86843 | G60654-0806 | 7253-86843 | 3/4-16 | 3/8-18 |
| 8MS-8MP90 | 86844 | G60654-0808 | 7253-86844 | 3/4-16 | 1/2-14 |
| 8MS-12MP90 | 86855 | G60654-0812 | 7253-26775 | 3/4-16 | 3/4-14 |
| 10MS-6MP90 | 86854 | G60654-1006 | 7253-26715 | 7/8-14 | 3/8-18 |
| 10MS-8MP90 | 86845 | G60654-1008 | 7253-86845 | 7/8-14 | 1/2-14 |
| 10MS-12MP90 | 86846 | G60654-1012 | 7253-86846 | 7/8-14 | 3/4-14 |
| 12MS-8MP90 | 86847 | G60654-1208 | 7253-86847 | 1-1/16-14 | 1/2-14 |
| 12MS-12MP90 | 86848 | G60654-1212 | 7253-86848 | 1-1/16-14 | 3/4-14 |

* Brass Grade CA 380.



The World's Most Trusted Name in Belts, Hose and Hydraulics.

www.gates.com

L47

- EQUIPMENT
- HOSE/CPLG. SELECTION
- TECH. DATA
- EXT. & VERY HIGH PRESS. HOSE
- GS CPLGS.
- PCM CPLGS.
- PCS CPLGS.
- HIGH & MED. PRESS. HOSE
- MEGACRIMP® CPLGS.
- PC CPLGS.
- FIELD ATTACHABLE CPLGS.
- AIR BRAKE HOSE & CPLGS.
- MEGATECH® C5 HOSE & CPLGS.
- LOW PRESS. HOSE & CPLGS.
- C14 HOSE & CPLGS.
- POLARSEAL® HOSE & CPLGS.
- PWR. STG. HOSE & CPLGS.
- THERMO-PLASTIC HOSE & CPLGS.
- ADAPTERS
- QUICK DISCONNECT CPLGS.
- ACCESSORIES & ASSORTMENTS
- PART NUMBER INDEXES

Adapters — SAE to SAE (Brass) – G60 Series

For use up to SAE 100R5 maximum working pressure.

Note: Gates does not recommend mixing metal types in any application.

Male SAE 45° Flare on Run to Male Pipe NPTF – Brass*

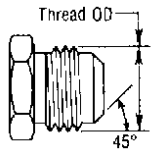

SAE 45° Flare Male (MS)

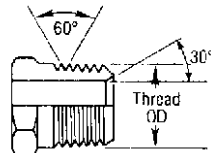

NPTF Solid Male (MP)



| Descr | # | |  | |
|----------------|-------------|------------|---|-----------|
| | | | MS | MP (NPTF) |
| 2MS-2MS-2MP | G60657-0202 | 7253-68025 | 1/8-27 | 1/8-27 |
| 3MS-3MS-2MP | G60657-0302 | 7253-68035 | 3/8-24 | 1/8-27 |
| 4MS-4MS-2MP | G60657-0402 | 7253-68045 | 7/16-20 | 1/8-27 |
| 4MS-4MS-4MP | G60657-0404 | 7253-68055 | 7/16-20 | 1/4-18 |
| 4MS-4MS-6MP | G60657-0406 | 7253-68065 | 7/16-20 | 3/8-18 |
| 4MS-4MS-8MP | G60657-0408 | 7253-68075 | 7/16-20 | 3/4-16 |
| 5MS-5MS-2MP | G60657-0502 | 7253-68085 | 1/2-20 | 1/8-27 |
| 5MS-5MS-4MP | G60657-0504 | 7253-68095 | 1/2-20 | 1/4-18 |
| 6MS-6MS-2MP | G60657-0602 | 7253-68105 | 5/8-18 | 1/8-27 |
| 6MS-6MS-4MP | G60657-0604 | 7253-68115 | 5/8-18 | 1/4-18 |
| 6MS-6MS-6MP | G60657-0606 | 7253-68125 | 5/8-18 | 3/8-18 |
| 6MS-6MS-8MP | G60657-0608 | 7253-68135 | 5/8-18 | 1/2-14 |
| 8MS-8MS-4MP | G60657-0804 | 7253-68145 | 3/4-16 | 1/4-18 |
| 8MS-8MS-6MP | G60657-0806 | 7253-68155 | 3/4-16 | 3/8-18 |
| 8MS-8MS-8MP | G60657-0808 | 7253-68165 | 3/4-16 | 1/2-14 |
| 8MS-8MS-12MP | G60657-0812 | 7253-68175 | 3/4-16 | 3/4-14 |
| 10MS-10MS-8MP | G60657-1008 | 7253-68185 | 7/8-14 | 1/2-14 |
| 10MS-10MS-12MP | G60657-1012 | 7253-68195 | 7/8-14 | 3/4-14 |
| 12MS-12MS-8MP | G60657-1208 | 7253-68205 | 1-1/16-14 | 1/2-14 |
| 12MS-12MS-12MP | G60657-1212 | 7253-68215 | 1-1/16-14 | 3/4-14 |

- EQUIPMENT
- HOSE/CPLG. SELECTION
- TECH. DATA
- EXT. & VERY HIGH PRESS. HOSE
- GS CPLGS.
- PCM CPLGS.
- PCS CPLGS.
- HIGH & MED. PRESS. HOSE
- MEGACRIMP® CPLGS.
- PC CPLGS.
- FIELD ATTACHABLE CPLGS.
- AIR BRAKE HOSE & CPLGS.
- MEGATECH™ C5 HOSE & CPLGS.
- LOW PRESS. HOSE & CPLGS.
- C14 HOSE & CPLGS.
- POLARSEAL® HOSE & CPLGS.
- PWR. STG. HOSE & CPLGS.
- THERMO-PLASTIC HOSE & CPLGS.
- ADAPTERS
- QUICK DISCONNECT CPLGS.
- ACCESSORIES & ASSORTMENTS
- PART NUMBER INDEXES

* Brass Grade CA 380.



Adapters — SAE to SAE (Brass) – G60 Series



For use up to SAE 100R5 maximum working pressure.
 Note: Gates does not recommend mixing metal types in any application.

Male Pipe NPTF to Male SAE 45° Flare to Male SAE 45° Flare – Brass*

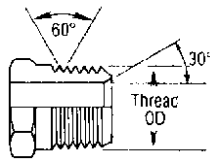

NPTF Solid Male (MP)

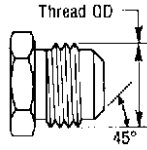

SAE 45° Flare Male (MS)

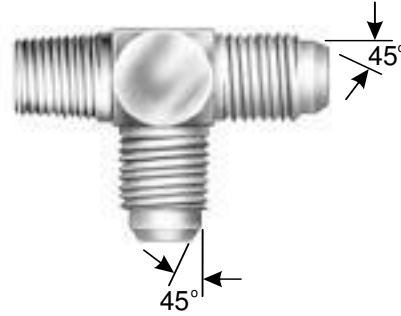

| Descr | # | | | |
|----------------|-------------|------------|-----------|-----------|
| | | | MP (NPTF) | MS |
| 2MP-3MS-3MS | G60659-0203 | 7253-68225 | 1/8-27 | 3/8-24 |
| 2MP-4MS-4MS | G60659-0204 | 7253-68235 | 1/8-27 | 7/16-20 |
| 2MP-5MS-5MS | G60659-0205 | 7253-68265 | 1/8-27 | 1/2-20 |
| 2MP-6MS-6MS | G60659-0206 | 7253-68285 | 1/8-27 | 5/8-18 |
| 4MP-4MS-4MS | G60659-0404 | 7253-68245 | 1/4-18 | 7/16-20 |
| 4MP-5MS-5MS | G60659-0405 | 7253-68275 | 1/4-18 | 1/2-20 |
| 4MP-6MS-6MS | G60659-0406 | 7253-68295 | 1/4-18 | 5/8-18 |
| 4MP-8MS-8MS | G60659-0408 | 7253-68325 | 1/4-18 | 3/4-16 |
| 6MP-4MS-4MS | G60659-0604 | 7253-68255 | 3/8-18 | 7/16-20 |
| 6MP-6MS-6MS | G60659-0606 | 7253-68305 | 3/8-18 | 5/8-18 |
| 6MP-8MS-8MS | G60659-0608 | 7253-68335 | 3/8-18 | 3/4-16 |
| 6MP-10MS-10MS | G60659-0610 | 7253-68355 | 3/8-18 | 7/8-14 |
| 8MP-6MS-6MS | G60659-0806 | 7253-68315 | 1/2-14 | 5/8-18 |
| 8MP-8MS-8MS | G60659-0808 | 7253-68345 | 1/2-14 | 3/4-16 |
| 8MP-10MS-10MS | G60659-0810 | 7253-68365 | 1/2-14 | 7/8-14 |
| 8MP-12MS-12MS | G60659-0812 | 7253-68375 | 1/2-14 | 1 1/16-14 |
| 12MP-12MS-12MS | G60659-1212 | 7253-68385 | 3/4-14 | 1 1/16-14 |

| |
|------------------------------|
| EQUIPMENT |
| HOSE/CPLG. SELECTION |
| TECH. DATA |
| EXT. & VERY HIGH PRESS. HOSE |
| GS CPLGS. |
| PCM CPLGS. |
| PCS CPLGS. |
| HIGH & MED. PRESS. HOSE |
| MEGACRIMP® CPLGS. |
| PC CPLGS. |
| FIELD ATTACHABLE CPLGS. |
| AIR BRAKE HOSE & CPLGS. |
| MEGATECH® C5 HOSE & CPLGS. |
| LOW PRESS. HOSE & CPLGS. |
| C14 HOSE & CPLGS. |
| POLARSEAL® HOSE & CPLGS. |
| PWR. STG. HOSE & CPLGS. |
| THERMO-PLASTIC HOSE & CPLGS. |
| ADAPTERS |
| QUICK DISCONNECT CPLGS. |
| ACCESSORIES & ASSORTMENTS |
| PART NUMBER INDEXES |

* Brass Grade CA 380.



Adapters — SAE to SAE (Brass) – G60 Series

For use up to SAE 100R5 maximum working pressure.

Note: Gates does not recommend mixing metal types in any application.

Male SAE 45° Flare to Female Pipe NPTF – Brass*

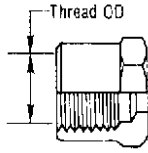
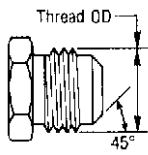

SAE 45° Flare Male (MS)

NPTF or NPSF Solid Female (FP)

| Descr | # | | |  | |
|-----------|-------------|-------------|------------|---|-----------|
| | | | | MS | FP (NPTF) |
| 2MS-2FP | G60660-0202 | G60660-0202 | 7253-68395 | 7/16-20 | 1/8-27 |
| 3MS-2FP | G60660-0302 | G60660-0302 | 7253-68405 | 7/16-20 | 1/8-27 |
| 4MS-2FP | 87770 | G60660-0402 | 7253-26205 | 7/16-20 | 1/8-27 |
| 4MS-6FP | 87776 | G60660-0406 | 7253-26265 | 7/16-20 | 1/2-14 |
| 4MS-8FP | G60660-0408 | G60660-0408 | 7253-68415 | 7/16-20 | 3/8-18 |
| 5MS-4FP | 87773 | G60660-0504 | 7253-26235 | 1/2-20 | 1/4-18 |
| 5MS-6FP | G60660-0506 | G60660-0506 | 7253-68425 | 1/2-20 | 3/8-18 |
| 6MS-2FP | G60660-0602 | G60660-0602 | 7253-68435 | 5/8-18 | 1/8-27 |
| 6MS-4FP | 87774 | G60660-0604 | 7253-26245 | 5/8-18 | 1/4-18 |
| 6MS-6FP | 87777 | G60660-0606 | 7253-26275 | 5/8-18 | 3/8-18 |
| 6MS-8FP | 87780 | G60660-0608 | 7253-26305 | 5/8-18 | 1/2-14 |
| 8MS-4FP | 87775 | G60660-0804 | 7253-26255 | 3/4-16 | 1/4-18 |
| 8MS-6FP | 87778 | G60660-0806 | 7253-26285 | 3/4-16 | 3/8-18 |
| 8MS-8FP | 87781 | G60660-0808 | 7253-26315 | 3/4-16 | 1/2-14 |
| 10MS-6FP | 87779 | G60660-1006 | 7253-26295 | 7/8-14 | 3/8-18 |
| 10MS-8FP | 87782 | G60660-1008 | 7253-26325 | 7/8-14 | 1/2-14 |
| 10MS-12FP | 87784 | G60660-1012 | 7253-26345 | 7/8-14 | 3/4-14 |
| 12MS-8FP | G60660-1208 | G60660-1208 | 7253-68445 | 1-1/16-14 | 1/2-14 |

- EQUIPMENT
- HOSE/CPLG. SELECTION
- TECH. DATA
- EXT. & VERY HIGH PRESS. HOSE
- GS CPLGS.
- PCM CPLGS.
- PCS CPLGS.
- HIGH & MED. PRESS. HOSE
- MEGACRIMP® CPLGS.
- PC CPLGS.
- FIELD ATTACHABLE CPLGS.
- AIR BRAKE HOSE & CPLGS.
- MEGATECH™ C5 HOSE & CPLGS.
- LOW PRESS. HOSE & CPLGS.
- C14 HOSE & CPLGS.
- POLARSEAL® HOSE & CPLGS.
- PWR. STG. HOSE & CPLGS.
- THERMO-PLASTIC HOSE & CPLGS.
- ADAPTERS
- QUICK DISCONNECT CPLGS.
- ACCESSORIES & ASSORTMENTS
- PART NUMBER INDEXES

* Brass Grade CA 380.



Adapters — SAE to SAE (Brass) — G60 Series



For use up to SAE 100R5 maximum working pressure.
 Note: Gates does not recommend mixing metal types in any application.

Male SAE 45° Flare to Female Pipe NPTF — Brass* — 90°

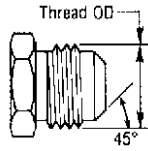

SAE 45° Flare Male (MS)

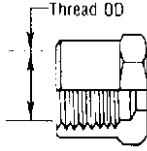

NPTF or NPSF Solid Female (FP)

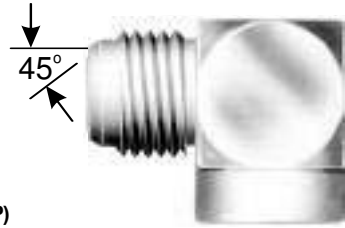

| Descr | # | | |  | |
|-------------|-------------|-------------|------------|---|-----------|
| | | | | MS | FP (NPTF) |
| 3MS-2FP90 | G60664-0302 | G60664-0302 | 7253-68455 | 3/8-24 | 1/8-27 |
| 4MS-2FP90 | 87790 | G60664-0402 | 7253-26405 | 7/16-20 | 1/8-27 |
| 4MS-4FP90 | 87792 | G60664-0404 | 7253-26425 | 7/16-20 | 1/4-18 |
| 4MS-6FP90 | 87795 | G60664-0406 | 7253-26455 | 7/16-20 | 3/8-18 |
| 5MS-2FP90 | 87791 | G60664-0502 | 7253-26415 | 1/2-20 | 1/8-27 |
| 5MS-4FP90 | G60664-0504 | G60664-0504 | 7253-68465 | 1/2-20 | 1/4-18 |
| 6MS-4FP90 | 87794 | G60664-0604 | 7253-26445 | 5/8-18 | 1/4-18 |
| 6MS-6FP90 | 87796 | G60664-0606 | 7253-26465 | 5/8-18 | 3/8-18 |
| 8MS-6FP90 | 87797 | G60664-0806 | 7253-26475 | 3/4-16 | 3/8-18 |
| 8MS-8FP90 | 87799 | G60664-0808 | 7253-26495 | 3/4-16 | 1/2-14 |
| 10MS-6FP90 | 87798 | G60664-1006 | 7253-26485 | 7/8-14 | 3/8-18 |
| 10MS-8FP90 | 87800 | G60664-1008 | 7253-26505 | 7/8-14 | 1/2-14 |
| 12MS-8FP90 | 87801 | G60664-1208 | 7253-26515 | 1-1/16-14 | 1/2-14 |
| 12MS-12FP90 | 87802 | G60664-1212 | 7253-26525 | 1-1/16-14 | 3/4-14 |

- EQUIPMENT
- HOSE/CPLG. SELECTION
- TECH. DATA
- EXT. & VERY HIGH PRESS. HOSE
- GS CPLGS.
- PCM CPLGS.
- PCS CPLGS.
- HIGH & MED. PRESS. HOSE
- MEGACRIMP® CPLGS.
- PC CPLGS.
- FIELD ATTACHABLE CPLGS.
- AIR BRAKE HOSE & CPLGS.
- MEGATECH™ C5 HOSE & CPLGS.
- LOW PRESS. HOSE & CPLGS.
- C14 HOSE & CPLGS.
- POLARSEAL® HOSE & CPLGS.
- PWR. STG. HOSE & CPLGS.
- THERMO-PLASTIC HOSE & CPLGS.
- ADAPTERS
- QUICK DISCONNECT CPLGS.
- ACCESSORIES & ASSORTMENTS
- PART NUMBER INDEXES

* Brass Grade CA 380.



Adapters — SAE to SAE (Brass) – G60 Series

For use up to SAE 100R5 maximum working pressure.
 Note: Gates does not recommend mixing metal types in any application.

Male SAE 45° Flare – Brass* – Tee

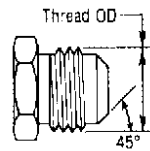

SAE 45° Flare Male (MS)

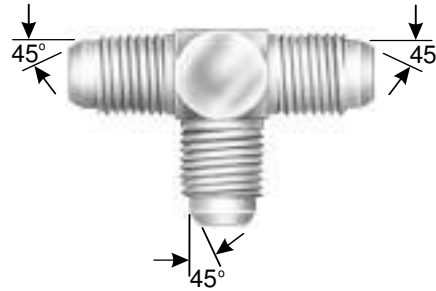

| Descr | # | |  | |
|----------------|-------------|------------|---|-----------|
| | | | MS | MS |
| 2MS-2MS-2MS | G60669-0202 | 7253-68475 | 5/16-24 | 5/16-24 |
| 3MS-3MS-3MS | G60669-0303 | 7253-68485 | 3/8-24 | 3/8-24 |
| 4MS-4MS-4MS | G60669-0404 | 7253-68495 | 7/16-20 | 7/16-20 |
| 4MS-4MS-6MS | G60669-0406 | 7253-68505 | 7/16-20 | 5/8-18 |
| 5MS-5MS-4MS | G60669-0504 | 7253-68515 | 1/2-20 | 7/16-20 |
| 5MS-5MS-5MS | G60669-0505 | 7253-68525 | 1/2-20 | 1/2-20 |
| 6MS-4MS-4MS | G60670-0604 | 7253-68695 | 5/8-18 | 7/16-20 |
| 6MS-4MS-6MS | G60671-0604 | 7253-68735 | 5/8-18 | 7/16-20 |
| 6MS-6MS-4MS | G60669-0604 | 7253-68535 | 5/8-18 | 7/16-20 |
| 6MS-6MS-6MS | G60669-0606 | 7253-68545 | 5/8-18 | 5/8-18 |
| 6MS-6MS-8MS | G60669-0608 | 7253-68555 | 5/8-18 | 3/4-16 |
| 6MS-6MS-10MS | G60669-0610 | 7253-68565 | 5/8-18 | 7/8-14 |
| 8MS-4MS-8MS | G60671-0804 | 7253-68745 | 3/4-16 | 7/16-20 |
| 8MS-8MS-4MS | G60669-0804 | 7253-68575 | 3/4-16 | 7/16-20 |
| 8MS-6MS-6MS | G60670-0806 | 7253-68705 | 3/4-16 | 5/8-18 |
| 8MS-6MS-8MS | G60671-0806 | 7253-68755 | 3/4-16 | 5/8-18 |
| 8MS-8MS-6MS | G60669-0806 | 7253-68585 | 3/4-16 | 5/8-18 |
| 8MS-8MS-8MS | G60669-0808 | 7253-68595 | 3/4-16 | 3/4-16 |
| 8MS-8MS-10MS | G60669-0810 | 7253-68605 | 3/4-16 | 7/8-14 |
| 8MS-8MS-12MS | G60669-0812 | 7253-68615 | 3/4-16 | 1 1/16-14 |
| 10MS-10MS-4MS | G60669-1004 | 7253-68625 | 7/8-14 | 7/16-20 |
| 10MS-6MS-6MS | G60670-1006 | 7253-68715 | 7/8-14 | 5/8-18 |
| 10MS-6MS-10MS | G60671-1006 | 7253-68765 | 7/8-14 | 5/8-18 |
| 10MS-10MS-6MS | G60669-1006 | 7253-68635 | 7/8-14 | 5/8-18 |
| 10MS-8MS-8MS | G60670-1008 | 7253-68725 | 7/8-14 | 3/4-16 |
| 10MS-8MS-10MS | G60671-1008 | 7253-68775 | 7/8-14 | 3/4-16 |
| 10MS-10MS-8MS | G60669-1008 | 7253-68645 | 7/8-14 | 3/4-16 |
| 10MS-10MS-10MS | G60669-1010 | 7253-68655 | 7/8-14 | 7/8-14 |
| 12MS-12MS-8MS | G60669-1208 | 7253-68665 | 1 1/16-14 | 3/4-16 |
| 12MS-10MS-12MS | G60671-1210 | 7253-68785 | 1 1/16-14 | 7/8-14 |
| 12MS-12MS-10MS | G60669-1210 | 7253-68675 | 1 1/16-14 | 7/8-14 |
| 12MS-12MS-12MS | G60669-1212 | 7253-68685 | 1 1/16-14 | 1 1/16-14 |

* Brass Grade CA 380.



Adapters — SAE to SAE (Brass) — G60 Series

For use up to SAE 100R5 maximum working pressure.
 Note: Gates does not recommend mixing metal types in any application.

Male SAE 45° Flare — Brass* — Cross

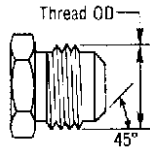

SAE 45° Flare Male (MS)

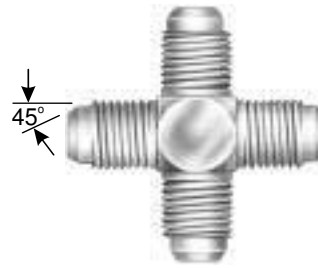

| Descr | # | |  |
|-----------|-------------|------------|---|
| 4MS-CROSS | G60680-0404 | 7253-68795 | 7/16-20 |
| 5MS-CROSS | G60680-0505 | 7253-68805 | 1/2-20 |
| 6MS-CROSS | G60680-0606 | 7253-68815 | 5/8-18 |
| 8MS-CROSS | G60680-0808 | 7253-68825 | 3/4-16 |

SAE Tubing Sleeve (JIC Sleeve)



| Descr | # | |  |
|-------|-------------|------------|---|
| | | | " |
| 4STS | G60684-0004 | 7253-68855 | 1/4 |
| 5STS | G60684-0005 | 7253-68865 | 5/16 |
| 6STS | G60684-0006 | 7253-68875 | 3/8 |
| 8STS | G60684-0008 | 7253-68885 | 1/2 |
| 10STS | G60684-0010 | 7253-68895 | 5/8 |
| 12STS | G60684-0012 | 7253-68905 | 3/4 |

EQUIPMENT
 HOSE/CPLG. SELECTION
 TECH. DATA
 EXT. & VERY HIGH PRESS. HOSE
 GS CPLGS.
 PCM CPLGS.
 PCS CPLGS.
 HIGH & MED. PRESS. HOSE
 MEGACRIMP® CPLGS.
 PC CPLGS.
 FIELD ATTACHABLE CPLGS.
 AIR BRAKE HOSE & CPLGS.
 MEGATECH® C5 HOSE & CPLGS.
 LOW PRESS. HOSE & CPLGS.
 C14 HOSE & CPLGS.
 POLARSEAL® HOSE & CPLGS.
 PWR. STG. HOSE & CPLGS.
 THERMO-PLASTIC HOSE & CPLGS.
 ADAPTERS
 QUICK DISCONNECT CPLGS.
 ACCESSORIES & ASSORTMENTS
 PART NUMBER INDEXES

* Brass Grade CA 380.



Adapters — SAE to SAE (Brass) – G60 Series

For use up to SAE 100R5 maximum working pressure.
 Note: Gates does not recommend mixing metal types in any application.

SAE Tubing Sleeve Nut (JIC Nut)



| Descr | # | | 🌀 | ↔ |
|--------|-------------|------------|-----------|------|
| | | | | " |
| 4STSN | G60685-0004 | 7253-68915 | 7/16-20 | 1/4 |
| 5STSN | G60685-0005 | 7253-68925 | 1/2-20 | 5/16 |
| 6STSN | G60685-0006 | 7253-68935 | 5/8-18 | 3/8 |
| 8STSN | G60685-0008 | 7253-68945 | 3/4-16 | 1/2 |
| 10STSN | G60685-0010 | 7253-68955 | 7/8-14 | 5/8 |
| 12STSN | G60684-0012 | 7253-68965 | 1 1/16-14 | 3/4 |

Male SAE 45° Flare to Male Pipe NPTF Check Valve – Brass

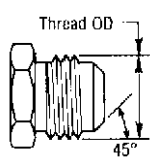

SAE 45° Flare Male (MS)

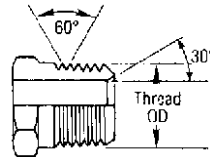

NPTF Solid Male (MP)



| Descr | # | | 🌀 | |
|------------|-------------|------------|---------|-----------|
| | | | MS | MP (NPTF) |
| 4MS-2MP-CV | G60690-0402 | 7253-68835 | 7/16-20 | 1/8-27 |
| 6MS-4MP-CV | G60690-0604 | 7253-68845 | 5/8-18 | 1/4-18 |

Male Inverted Plug – Brass

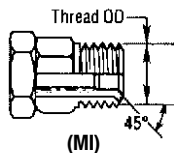

(MI)



| Descr | # | | 🌀 |
|----------|-------------|------------|---------|
| 3MI-PLUG | G60691-0003 | 7253-68975 | 3/8-24 |
| 4MI-PLUG | G60691-0004 | 7253-68985 | 7/16-24 |
| 5MI-PLUG | G60691-0005 | 7253-68995 | 1/2-20 |
| 6MI-PLUG | G60691-0006 | 7253-69005 | 5/8-18 |

* Brass Grade CA 380.

Adapters — SAE to SAE (Brass) – G60 Series

For use up to SAE 100R5 maximum working pressure.
 Note: Gates does not recommend mixing metal types in any application.

Female Inverted to Female Inverted – Brass

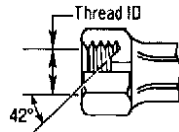

SAE Inverted Flare Solid Female

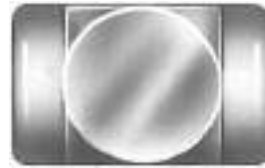

| Descr | # | |  |
|---------|-------------|------------|---|
| 2FI-2FI | G60693-0202 | 7253-69015 | 5/16-28 |
| 3FI-3FI | G60693-0303 | 7253-69025 | 3/8-24 |
| 4FI-4FI | G60693-0404 | 7253-69035 | 7/16-24 |
| 5FI-5FI | G60693-0505 | 7253-69045 | 1/2-20 |
| 6FI-6FI | G60693-0606 | 7253-69055 | 5/8-18 |
| 8FI-8FI | G60693-0808 | 7253-69065 | 3/4-16 |

Female Flat-Face O-Ring Cap

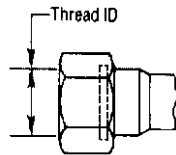

Female Flat- Face O-Ring Swivel (FFORX)



| Descr | # | |  |
|------------|-------|-------------|---|
| 4FFOR-CAP | 87347 | G60701-0004 | 9/16-18 |
| 6FFOR-CAP | 87348 | G60701-0006 | 11/16-16 |
| 8FFOR-CAP | 87349 | G60701-0008 | 13/16-16 |
| 10FFOR-CAP | 87350 | G60701-0010 | 1-14 |
| 12FFOR-CAP | 87351 | G60701-0012 | 1-3/16-12 |
| 16FFOR-CAP | 87352 | G60701-0016 | 1-7/16-12 |
| 20FFOR-CAP | 87353 | G60701-0020 | 1-11/16-12 |
| 24FFOR-CAP | 87354 | G60701-0024 | 2-12 |

| |
|------------------------------|
| EQUIPMENT |
| HOSE/CPLG. SELECTION |
| TECH. DATA |
| EXT. & VERY HIGH PRESS. HOSE |
| GS CPLGS. |
| PCM CPLGS. |
| PCS CPLGS. |
| HIGH & MED. PRESS. HOSE |
| MEGACRIMP® CPLGS. |
| PC CPLGS. |
| FIELD ATTACHABLE CPLGS. |
| AIR BRAKE HOSE & CPLGS. |
| MEGATECH® C5 HOSE & CPLGS. |
| LOW PRESS. HOSE & CPLGS. |
| C14 HOSE & CPLGS. |
| POLARSEAL® HOSE & CPLGS. |
| PWR. STG. HOSE & CPLGS. |
| THERMO-PLASTIC HOSE & CPLGS. |
| ADAPTERS |
| QUICK DISCONNECT CPLGS. |
| ACCESSORIES & ASSORTMENTS |
| PART NUMBER INDEXES |

* Brass Grade CA 380.



Adapters — SAE to SAE – G60 Series

For use up to SAE 100R2 maximum working pressure.

Male Flat-Face O-Ring Plug

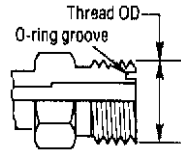

Male Flat- Face O-Ring (MFFOR)

| Descr | # | | |  | | O-Ring # | |
|--------------|-------|-------------|------------|---|-------|-------------|-----------|
| | | | | | | | |
| 4MFFOR-PLUG | 87339 | G60702-0004 | 7253-32045 | 9/16-18 | 82560 | G60698-0004 | 7254-0125 |
| 6MFFOR-PLUG | 87340 | G60702-0006 | 7253-32055 | 11/16-16 | 82561 | G60698-0006 | 7254-0126 |
| 8MFFOR-PLUG | 87341 | G60702-0008 | 7253-32065 | 13/16-16 | 82562 | G60698-0008 | 7254-0127 |
| 10MFFOR-PLUG | 87342 | G60702-0010 | 7253-32075 | 1-14 | 82563 | G60698-0010 | 7254-0128 |
| 12MFFOR-PLUG | 87343 | G60702-0012 | 7253-32085 | 1-3/16-12 | 82564 | G60698-0012 | 7254-0129 |
| 16MFFOR-PLUG | 87344 | G60702-0016 | 7253-32095 | 1-7/16-12 | 82565 | G60698-0016 | 7254-0130 |
| 20MFFOR-PLUG | 87345 | G60702-0020 | 7253-32105 | 1-1/16-12 | 82566 | G60698-0020 | 7254-0131 |
| 24MFFOR-PLUG | 87346 | G60702-0024 | 7253-32115 | 2-12 | 82567 | G60698-0024 | 7254-0132 |

Male Flat-Face O-Ring to Female Flat-Face Swivel – 90°

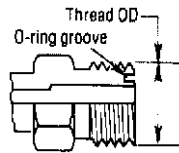

Male Flat- Face O-Ring (MFFOR)

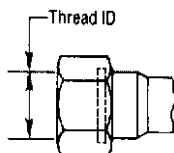

Female Flat- Face O-Ring Swivel (FFORX)



| Descr | # | | |  | | O-Ring # | | |
|-----------------|-------|-------------|------------|---|----------|----------|-------------|-----------|
| | | | | MFFOR | FFORX | | | |
| 6MFFOR-6FFORX90 | 87833 | G60724-0606 | 7253-31905 | 11/16-16 | 11/16-16 | 82561 | G60698-0006 | 7254-0126 |

EQUIPMENT
HOSE/CPLG. SELECTION
TECH. DATA
EXT. & VERY HIGH PRESS. HOSE
GS CPLGS.
PCM CPLGS.
PCS CPLGS.
HIGH & MED. PRESS. HOSE
MEGACRIMP® CPLGS.
PC CPLGS.
FIELD ATTACHABLE CPLGS.
AIR BRAKE HOSE & CPLGS.
MEGATECH®/C5 HOSE & CPLGS.
LOW PRESS. HOSE & CPLGS.
C14 HOSE & CPLGS.
POLARSEAL® HOSE & CPLGS.
PWR. STG. HOSE & CPLGS.
THERMO-PLASTIC HOSE & CPLGS.
ADAPTERS
QUICK DISCONNECT CPLGS.
ACCESSORIES & ASSORTMENTS
PART NUMBER INDEXES

Adapters — SAE to SAE – G60 Series

For use up to SAE 100R2 maximum working pressure.

Male Flat-Face O-Ring on Run to Female Flat-Face Swivel - Tee

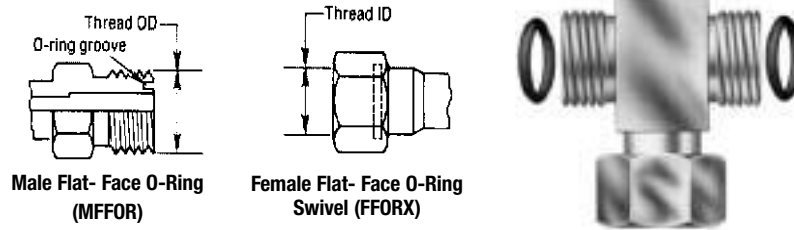

| Descr | # | | |  | | O-Ring # | | |
|----------------------|-------|-------------|------------|---|----------|----------|-------------|-----------|
| | | | | MFFOR | FFORX | | | |
| 4MFFOR-4MFFOR-4FFORX | 87759 | G60742-0404 | 7253-31805 | 9/16-18 | 9/16-18 | 82560 | G60698-0004 | 7254-0125 |
| 6MFFOR-6MFFOR-6FFORX | 87760 | G60742-0606 | 7253-31815 | 11/16-16 | 11/16-16 | 82561 | G60698-0006 | 7254-0126 |
| 8MFFOR-8MFFOR-8FFORX | 87761 | G60742-0808 | 7253-31825 | 13/16-16 | 13/16-16 | 82562 | G60698-0008 | 7254-0127 |

Male Flat-Face O-Ring to Male Pipe NPTF

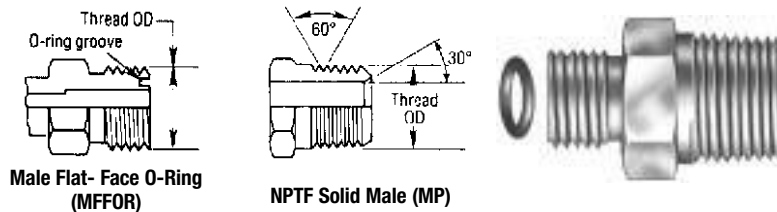

| Descr | # | | |  | | O-Ring # | | |
|--------------|-------|-------------|------------|---|--------------|----------|-------------|-----------|
| | | | | MFFOR | MP (NPTF) | | | |
| 4MFFOR-2MP | 87840 | G60770-0402 | 7253-30615 | 9/16-18 | 1/8-27 | 82560 | G60698-0004 | 7254-0125 |
| 4MFFOR-4MP | 87841 | G60770-0404 | 7253-30625 | 9/16-18 | 1/4-18 | 82560 | G60698-0004 | 7254-0125 |
| 4MFFOR-6MP | 87842 | G60770-0406 | 7253-30635 | 9/16-18 | 3/8-18 | 82560 | G60698-0004 | 7254-0125 |
| 6MFFOR-4MP | 87843 | G60770-0604 | 7253-30645 | 11/16-16 | 1/4-18 | 82561 | G60698-0006 | 7254-0126 |
| 6MFFOR-6MP | 87844 | G60770-0606 | 7253-30655 | 11/16-16 | 3/8-18 | 82561 | G60698-0006 | 7254-0126 |
| 6MFFOR-8MP | 87845 | G60770-0608 | 7253-30665 | 11/16-16 | 1/2-14 | 82561 | G60698-0006 | 7254-0126 |
| 8MFFOR-6MP | 87846 | G60770-0806 | 7253-30675 | 13/16-16 | 3/8-18 | 82562 | G60698-0008 | 7254-0127 |
| 8MFFOR-8MP | 87847 | G60770-0808 | 7253-30685 | 13/16-16 | 1/2-14 | 82562 | G60698-0008 | 7254-0127 |
| 10MFFOR-8MP | 87848 | G60770-1008 | 7253-30695 | 1-14 | 1/2-14 | 82563 | G60698-0010 | 7254-0128 |
| 12MFFOR-12MP | 87849 | G60770-1212 | 7253-30705 | 1-3/16-12 | 3/4-14 | 82564 | G60698-0012 | 7254-0129 |
| 16MFFOR-16MP | 87850 | G60770-1616 | 7253-30715 | 1-7/16-12 | 1-11-1/2 | 82565 | G60698-0016 | 7254-0130 |
| 20MFFOR-20MP | 87851 | G60770-2020 | 7253-30725 | 1-11/16-12 | 1-1/4-11-1/2 | 82566 | G60698-0020 | 7254-0131 |

EQUIPMENT
HOSE/CPLG. SELECTION
TECH. DATA
EXT. & VERY HIGH PRESS. HOSE
GS CPLGS.
PCM CPLGS.
PCS CPLGS.
HIGH & MED. PRESS. HOSE
MEGACRIMP® CPLGS.
PC CPLGS.
FIELD ATTACHABLE CPLGS.
AIR BRAKE HOSE & CPLGS.
MEGATECH® C5 HOSE & CPLGS.
LOW PRESS. HOSE & CPLGS.
C14 HOSE & CPLGS.
POLARSEAL® HOSE & CPLGS.
PWR. STG. HOSE & CPLGS.
THERMO-PLASTIC HOSE & CPLGS.
ADAPTERS
QUICK DISCONNECT CPLGS.
ACCESSORIES & ASSORTMENTS
PART NUMBER INDEXES



Adapters — SAE to SAE – G60 Series

For use up to SAE 100R2 maximum working pressure.

Male Flat-Face O-Ring to Male O-Ring Boss

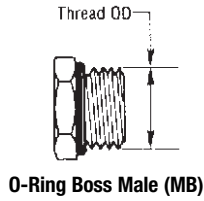
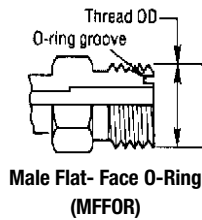

| Descr | # | | | O-Ring | | FFOR O-Ring # | | | MB O-Ring # | | |
|---------------|-------|-------------|------------|------------|-----------|---------------|-------------|-----------|-------------|-------------|-----------|
| | | | | MFFOR | MB | | | | | | |
| 4MFFOR-4MB | 87860 | G60800-0404 | 7253-30015 | 9/16-18 | 7/16-20 | 82560 | G60698-0004 | 7254-0125 | 82501 | G60248-0004 | 7254-0004 |
| 4MFFOR-6MB | 87854 | G60800-0406 | 7253-29905 | 9/16-18 | 9/16-18 | 82560 | G60698-0004 | 7254-0125 | 82503 | G60248-0006 | 7254-0006 |
| 4MFFOR-8MB | 87852 | G60800-0408 | 7253-30115 | 9/16-18 | 3/4-16 | 82560 | G60698-0004 | 7254-0125 | 82504 | G60248-0008 | 7254-0008 |
| 6MFFOR-6MB | 87861 | G60800-0606 | 7253-30025 | 11/16-16 | 9/16-18 | 82561 | G60698-0006 | 7254-0126 | 82503 | G60248-0006 | 7254-0006 |
| 6MFFOR-8MB | 87858 | G60800-0608 | 7253-29925 | 11/16-16 | 3/4-16 | 82561 | G60698-0006 | 7254-0126 | 82504 | G60248-0008 | 7254-0008 |
| 6MFFOR-10MB | 87853 | G60800-0610 | 7253-30095 | 11/16-16 | 7/8-14 | 82561 | G60698-0006 | 7254-0126 | 82505 | G60248-0010 | 7254-0010 |
| 8MFFOR-6MB | 87857 | G60800-0806 | 7253-29915 | 13/16-16 | 9/16-18 | 82562 | G60698-0008 | 7254-0127 | 82503 | G60248-0006 | 7254-0006 |
| 8MFFOR-8MB | 87862 | G60800-0808 | 7253-30035 | 13/16-16 | 3/4-16 | 82562 | G60698-0008 | 7254-0127 | 82504 | G60248-0008 | 7254-0008 |
| 8MFFOR-10MB | 87888 | G60800-0810 | 7253-30105 | 13/16-16 | 7/8-14 | 82562 | G60698-0008 | 7254-0127 | 82505 | G60248-0010 | 7254-0010 |
| 8MFFOR-12MB | 87859 | G60800-0812 | 7253-30125 | 13/16-16 | 1-1/16-12 | 82562 | G60698-0008 | 7254-0127 | 82506 | G60248-0012 | 7254-0012 |
| 10MFFOR-10MB | 87863 | G60800-1010 | 7253-30045 | 1-14 | 7/8-14 | 82563 | G60698-0010 | 7254-0128 | 82505 | G60248-0010 | 7254-0010 |
| 12MFFOR-8MB | 87855 | G60800-1208 | 7253-30135 | 1-3/16-12 | 3/4-16 | 82564 | G60698-0012 | 7254-0129 | 82504 | G60248-0008 | 7254-0008 |
| 12MFFOR-12MB | 87864 | G60800-1212 | 7253-30055 | 1-3/16-12 | 1-1/16-12 | 82564 | G60698-0012 | 7254-0129 | 82506 | G60248-0012 | 7254-0012 |
| 12MFFOR-16MB | 87856 | G60800-1216 | 7253-30175 | 1-3/16-12 | 1-5/16-12 | 82564 | G60698-0012 | 7254-0129 | 82508 | G60248-0016 | 7254-0016 |
| 16MFFOR-12MB | 87867 | G60800-1612 | 7253-30185 | 1-7/16-12 | 1-1/16-12 | 82565 | G60698-0016 | 7254-0130 | 82506 | G60248-0012 | 7254-0012 |
| 16MFFOR-16MB | 87865 | G60800-1616 | 7253-50255 | 1-7/16-12 | 1-5/16-12 | 82565 | G60698-0016 | 7254-0130 | 82508 | G60248-0016 | 7254-0016 |
| 16MFFOR-16MBL | 87884 | G60801-1616 | 7253-30155 | 1-7/16-12 | 1-5/16-12 | 82565 | G60698-0016 | 7254-0130 | 82508 | G60248-0016 | 7254-0016 |
| 20MFFOR-16MB | 87868 | G60800-2016 | 7253-30145 | 1-11/16-12 | 1-5/16-12 | 82566 | G60698-0020 | 7254-0131 | 82508 | G60248-0016 | 7254-0016 |
| 20MFFOR-20MB | 87866 | G60800-2020 | 7253-30075 | 1-11/16-12 | 1-5/8-12 | 82566 | G60698-0020 | 7254-0131 | 82509 | G60248-0020 | 7254-0020 |
| 20MFFOR-20MBL | 87885 | G60801-2020 | 7253-30165 | 1-11/16-12 | 1-5/8-12 | 82566 | G60698-0020 | 7254-0131 | 82509 | G60248-0020 | 7254-0020 |

Male Flat-Face O-Ring to Male O-Ring Boss – 45°

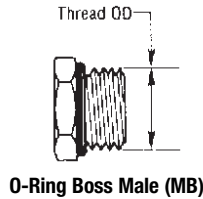
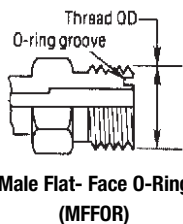

| Descr | # | | | O-Ring | | FFOR O-Ring # | | | MB O-Ring # | | |
|---------------|-------|-------------|------------|----------|---------|---------------|-------------|-----------|-------------|-------------|-----------|
| | | | | MFFOR | MB | | | | | | |
| 4MFFOR-6MB45 | 87675 | G60805-0406 | 7253-30305 | 9/16-18 | 9/16-18 | 82560 | G60698-0004 | 7254-0125 | 82503 | G60248-0006 | 7254-0006 |
| 6MFFOR-6MB45 | 87676 | G60805-0606 | 7253-30225 | 11/16-16 | 9/16-18 | 82561 | G60698-0006 | 7254-0126 | 82503 | G60248-0006 | 7254-0006 |
| 8MFFOR-10MB45 | 87679 | G60805-0810 | 7253-30295 | 13/16-16 | 7/8-14 | 82562 | G60698-0008 | 7254-0127 | 82505 | G60248-0010 | 7254-0010 |

Adapters — SAE to SAE – G60 Series

For use up to SAE 100R2 maximum working pressure.

Male Flat-Face O-Ring to Male O-Ring Boss – 90°

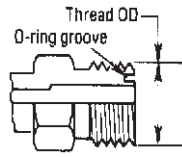

Male Flat-Face O-Ring (MFFOR)

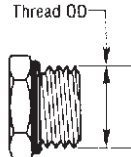

O-Ring Boss Male (MB)



| Descr | # | | |  | | FFOR O-Ring # | | | MB O-Ring # | | |
|----------------|-------|-------------|------------|---|-----------|---------------|-------------|-----------|-------------|-------------|-----------|
| | | | | MFFOR | MB | | | | | | |
| 4MFFOR-4MB90 | 87870 | G60810-0404 | 7253-30415 | 9/16-18 | 7/16-20 | 82560 | G60698-0004 | 7254-0125 | 82501 | G60248-0004 | 7254-0004 |
| 6MFFOR-4MB90 | 87886 | G60810-0604 | 7253-30495 | 11/16-16 | 7/16-20 | 82561 | G60698-0006 | 7254-0126 | 82501 | G60248-0004 | 7254-0004 |
| 6MFFOR-6MB90 | 87871 | G60810-0606 | 7253-30425 | 11/16-16 | 9/16-18 | 82561 | G60698-0006 | 7254-0126 | 82503 | G60248-0006 | 7254-0006 |
| 6MFFOR-10MB90 | 87877 | G60810-0610 | 7253-30505 | 11/16-16 | 7/8-14 | 82561 | G60698-0006 | 7254-0126 | 82505 | G60248-0010 | 7254-0010 |
| 8MFFOR-6MB90 | --- | G60810-0806 | 7253-66215 | 13/16-16 | 9/16-18 | 82562 | G60698-0008 | 7254-0127 | 82503 | G60248-0006 | 7254-0006 |
| 8MFFOR-8MB90 | 87872 | G60810-0808 | 7253-30435 | 13/16-16 | 3/4-16 | 82562 | G60698-0008 | 7254-0127 | 82504 | G60248-0008 | 7254-0008 |
| 8MFFOR-10MB90 | 87887 | G60810-0810 | 7253-30515 | 13/16-16 | 7/8-14 | 82562 | G60698-0008 | 7254-0127 | 82505 | G60248-0010 | 7254-0010 |
| 8MFFOR-12MB90 | 87889 | G60810-0812 | 7253-30525 | 13/16-16 | 1-1/16-12 | 82562 | G60698-0008 | 7254-0127 | 82506 | G60248-0012 | 7254-0012 |
| 10MFFOR-8MB90 | 87869 | G60810-1008 | 7253-30555 | 1-14 | 3/4-16 | 82563 | G60698-0010 | 7254-0128 | 82504 | G60248-0008 | 7254-0008 |
| 10MFFOR-10MB90 | 87873 | G60810-1010 | 7253-30445 | 1-14 | 7/8-14 | 82563 | G60698-0010 | 7254-0128 | 82505 | G60248-0010 | 7254-0010 |
| 12MFFOR-12MB90 | 87874 | G60810-1212 | 7253-30455 | 1-3/16-12 | 1-1/16-12 | 82564 | G60698-0012 | 7254-0129 | 82506 | G60248-0012 | 7254-0012 |
| 16MFFOR-12MB90 | 87754 | G60810-1612 | 7253-30545 | 1-7/16-12 | 1-1/16-12 | 82565 | G60698-0016 | 7254-0130 | 82506 | G60248-0012 | 7254-0012 |
| 16MFFOR-16MB90 | 87875 | G60810-1616 | 7253-30465 | 1-7/16-12 | 1-5/16-12 | 82565 | G60698-0016 | 7254-0130 | 82508 | G60248-0016 | 7254-0016 |
| 20MFFOR-20MB90 | 87876 | G60810-2020 | 7253-30475 | 1-11/16-12 | 1-5/8-12 | 82566 | G60698-0020 | 7254-0131 | 82509 | G60248-0020 | 7254-0020 |

Male Flat-Face O-Ring on Run to Male O-Ring Boss – Tee

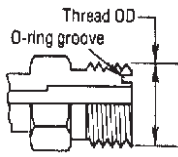

Male Flat-Face O-Ring (MFFOR)

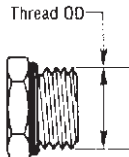

O-Ring Boss Male (MB)



| Descr | # | | |  | | FFOR O-Ring # | | | MB O-Ring # | | |
|----------------------|-------|-------------|------------|---|-----------|---------------|-------------|-----------|-------------|-------------|-----------|
| | | | | MFFOR | MB | | | | | | |
| 6MFFOR-6MFFOR-6MB | 87805 | G60820-0606 | 7253-31515 | 11/16-16 | 9/16-18 | 82561 | G60698-0006 | 7254-0126 | 82503 | G60248-0006 | 7254-0006 |
| 12MFFOR-12MFFOR-12MB | 87808 | G60820-1212 | 7253-31545 | 1-3/16-12 | 1-1/16-12 | 82564 | G60698-0012 | 7254-0129 | 82506 | G60248-0012 | 7254-0012 |
| 16MFFOR-16MFFOR-16MB | 87809 | G60820-1616 | 7253-31555 | 1-7/16-12 | 1-5/16-12 | 82565 | G60698-0016 | 7254-0130 | 82508 | G60248-0016 | 7254-0016 |

EQUIPMENT

HOSE/CPLG. SELECTION

TECH. DATA

EXT. & VERY HIGH PRESS. HOSE

GS CPLGS.

PCM CPLGS.

PCS CPLGS.

HIGH & MED. PRESS. HOSE

MEGACRIMP® CPLGS.

PC CPLGS.

FIELD ATTACHABLE CPLGS.

AIR BRAKE HOSE & CPLGS.

MEGATECH® C5 HOSE & CPLGS.

LOW PRESS. HOSE & CPLGS.

C14 HOSE & CPLGS.

POLARSEAL® HOSE & CPLGS.

PWR. STG. HOSE & CPLGS.

THERMO-PLASTIC HOSE & CPLGS.

ADAPTERS

QUICK DISCONNECT CPLGS.

ACCESSORIES & ASSORTMENTS

PART NUMBER INDEXES



Adapters — SAE to SAE – G60 Series

For use up to SAE 100R2 maximum working pressure.

Male Flat-Face O-Ring to Male O-Ring Boss to Male Flat-Face O-Ring – Tee

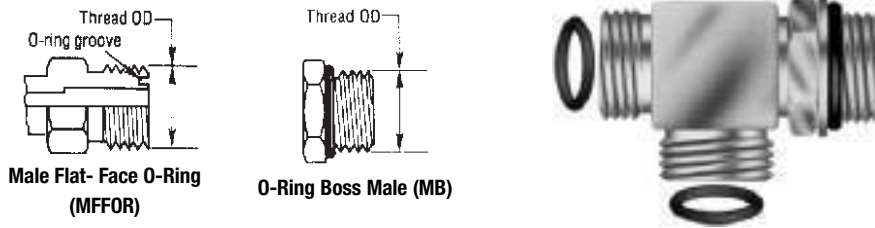

| Descr | # | | |  | | FFOR O-Ring # | | | MB O-Ring # | | |
|----------------------|-------|-------------|------------|---|---------|---------------|-------------|-----------|-------------|-------------|-----------|
| | | | | MFFOR | MB | | | | | | |
| 6MFFOR-6MB-6MFFOR | 87750 | G60821-0606 | 7253-31605 | 11/16-16 | 9/16-18 | 82561 | G60698-0006 | 7254-0126 | 82503 | G60248-0006 | 7254-0006 |
| 10MFFOR-10MB-10MFFOR | 87752 | G60821-1010 | 7253-31615 | 1-14 | 7/8-14 | 82563 | G60698-0010 | 7254-0128 | 82505 | G60248-0010 | 7254-0010 |

Male Flat-Face O-Ring to Male Flat-Face "O" Bulkhead – Tee

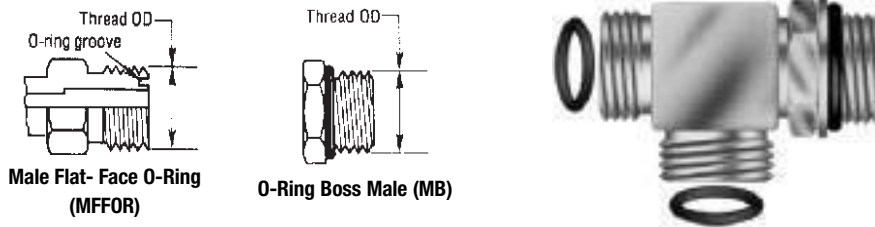

| Descr | # | | |  | | |
|------------------|-------------|------------|---------|---|----------|--|
| | | | | | | |
| 8-8-8MFFOR-BKHDT | G60748-0808 | 7253-32605 | 3/16-16 | 13/16-18 | 13/16-18 | |

Female Flat-Face Swivel to Male JIC 37° Flare

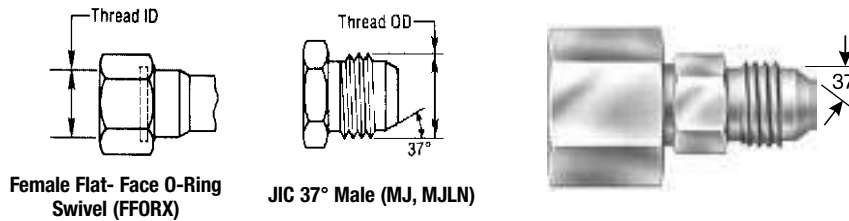

| Descr | # | | |  | |
|--------------|-------|-------------|------------|---|-----------|
| | | | | FFORX | MJ |
| 4FFORX-4MJ | 87881 | G60880-0404 | 7253-31705 | 9/16-18 | 7/16-20 |
| 6FFORX-6MJ | 87882 | G60880-0606 | 7253-31715 | 11/16-16 | 9/16-18 |
| 8FFORX-8MJ | 87883 | G60880-0808 | 7253-31725 | 13/16-16 | 3/4-16 |
| 10FFORX-10MJ | 87878 | G60880-1010 | 7253-31735 | 1-14 | 7/8-14 |
| 12FFORX-12MJ | 87879 | G60880-1212 | 7253-31745 | 1-3/16-12 | 1-1/16-12 |
| 16FFORX-16MJ | 87880 | G60880-1616 | 7253-31755 | 1-7/16-12 | 1-5/16-12 |

Adapters — SAE to SAE – G60 Series

For use up to SAE 100R2 maximum working pressure.

Code 61 O-Ring Flange Cap

Note: For maintenance use only. Not to be used under pressure.

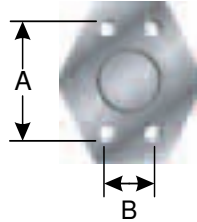

| Descr | # | | A " | B " |
|----------|-------------|------------|------|------|
| 12FL-CAP | G60897-0012 | 7253-66115 | 1.88 | 0.41 |
| 16FL-CAP | G60897-0016 | 7253-66125 | 2.06 | 0.41 |
| 20FL-CAP | G60897-0020 | 7253-66135 | 2.31 | 0.47 |
| 24FL-CAP | G60897-0024 | 7253-66145 | 2.75 | 0.53 |
| 32FL-CAP | G60897-0032 | 7253-66155 | 3.06 | 0.53 |

Code 61 O-Ring Flange to Male JIC 37° Flare

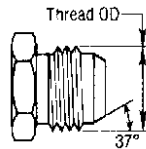

JIC 37° Male (MJ, MJLN)

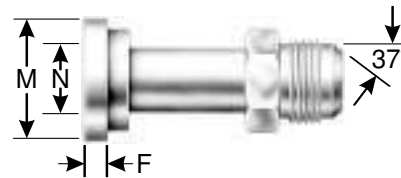

| Descr | # | | | O-Ring* # | N | M | F | O-Ring* # | | |
|-----------|-------|-------------|------------|-----------|-------|------|------|-----------|-------------|-----------|
| | | | | | | | | | | |
| 8FL-8MJ | 86931 | G60900-0808 | 7253-86931 | 3/4-16 | 1/2 | 1.19 | 0.27 | 82510 | G60898-0008 | 7254-0001 |
| 12FL-12MJ | 86932 | G60900-1212 | 7253-86932 | 1-1/16-12 | 3/4 | 1.50 | 0.27 | 82511 | G60898-0012 | 7254-0007 |
| 16FL-16MJ | 86933 | G60900-1616 | 7253-86933 | 1-5/16-12 | 1 | 1.75 | 0.32 | 82512 | G60898-0016 | 7254-0009 |
| 20FL-20MJ | 86934 | G60900-2020 | 7253-86934 | 1-5/8-12 | 1-1/4 | 2.00 | 0.32 | 82513 | G60898-0020 | 7254-0011 |
| 24FL-24MJ | 86935 | G60900-2424 | 7253-86935 | 1-7/8-12 | 1-1/2 | 2.38 | 0.32 | 82514 | G60898-0024 | 7254-0013 |
| 32FL-32MJ | 86936 | G60900-3232 | 7253-86936 | 2-1/2-12 | 2 | 2.81 | 0.38 | 82515 | G60898-0032 | 7254-0015 |

*O-Ring not included.

EQUIPMENT

HOSE/CPLG. SELECTION

TECH. DATA

EXT. & VERY HIGH PRESS. HOSE

GS CPLGS.

PCM CPLGS.

PCS CPLGS.

HIGH & MED. PRESS. HOSE

MEGACRIMP® CPLGS.

PC CPLGS.

FIELD ATTACHABLE CPLGS.

AIR BRAKE HOSE & CPLGS.

MEGATECH® C5 HOSE & CPLGS.

LOW PRESS. HOSE & CPLGS.

C14 HOSE & CPLGS.

POLARSEAL® HOSE & CPLGS.

PWR. STG. HOSE & CPLGS.

THERMO-PLASTIC HOSE & CPLGS.

ADAPTERS

QUICK DISCONNECT CPLGS.

ACCESSORIES & ASSORTMENTS

PART NUMBER INDEXES



The World's Most Trusted Name in Belts, Hose and Hydraulics.

www.gates.com

L61

Adapters — SAE to SAE – G60 Series

For use up to SAE 100R2 maximum working pressure.

Code 61 O-Ring Flange to Male JIC 37° Flare – High Pressure†

(No braze joints, solid one-piece construction for increased reliability)

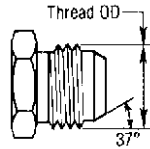

JIC 37° Male (MJ, MJLN)



| Descr | # | | | | N | M | F | O-Ring* # | | |
|-------------|-------|-------------|------------|-----------|-------|------|------|-----------|-------------|-----------|
| | | | | | | | | | | |
| 12FL5K-12MJ | 87960 | G60901-1212 | 7253-13015 | 1-1/16-12 | 3/4 | 1.50 | 0.27 | 82511 | G60898-0012 | 7254-0007 |
| 16FL5K-12MJ | 87993 | G60901-1612 | 7253-12405 | 1-1/16-12 | 1 | 1.75 | 0.32 | 82512 | G60898-0016 | 7254-0009 |
| 16FL5K-16MJ | 87961 | G60901-1616 | 7253-13035 | 1-5/16-12 | 1 | 1.75 | 0.32 | 82512 | G60898-0016 | 7254-0009 |
| 16FL5K-20MJ | 87994 | G60901-1620 | 7253-12425 | 1-5/8-12 | 1 | 1.75 | 0.32 | 82512 | G60898-0016 | 7254-0009 |
| 20FL4K-16MJ | 88010 | G60901-2016 | 7253-12485 | 1-5/16-12 | 1-1/4 | 2.00 | 0.32 | 82513 | G60898-0020 | 7254-0011 |
| 20FL4K-20MJ | 88011 | G60901-2020 | 7253-12475 | 1-5/8-12 | 1-1/4 | 2.00 | 0.32 | 82513 | G60898-0020 | 7254-0011 |

*O-Ring not included.

*N = flange size

†FL5K maximum working pressure is 5,000 psi; FL4K maximum working pressure is 4,000 psi.

Code 61 O-Ring Flange to Male JIC 37° Flare – 45°

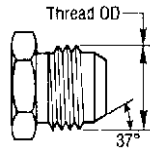

JIC 37° Male (MJ, MJLN)

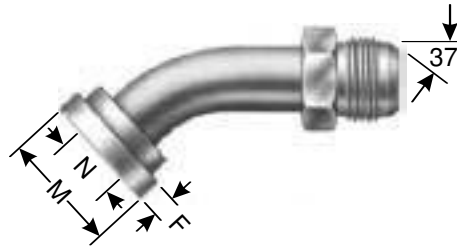

| Descr | # | | | | N | M | F | O-Ring* # | | |
|-------------|-------|-------------|------------|-----------|-------|------|------|-----------|-------------|-----------|
| | | | | | | | | | | |
| 8FL-8MJ45 | 86937 | G60905-0808 | 7253-86937 | 3/4-16 | 1/2 | 1.19 | 0.27 | 82510 | G60898-0008 | 7254-0001 |
| 12FL-12MJ45 | 86938 | G60905-1212 | 7253-86938 | 1-1/16-12 | 3/4 | 1.50 | 0.27 | 82511 | G60898-0012 | 7254-0007 |
| 16FL-16MJ45 | 86939 | G60905-1616 | 7253-86939 | 1-5/16-12 | 1 | 1.75 | 0.32 | 82512 | G60898-0016 | 7254-0009 |
| 20FL-20MJ45 | 86941 | G60905-2020 | 7253-86941 | 1-5/8-12 | 1-1/4 | 2.00 | 0.32 | 82513 | G60898-0020 | 7254-0011 |
| 24FL-24MJ45 | 86942 | G60905-2424 | 7253-86942 | 1-7/8-12 | 1-1/2 | 2.38 | 0.32 | 82514 | G60898-0024 | 7254-0013 |
| 32FL-32MJ45 | 86943 | G60905-3232 | 7253-86943 | 2-1/2-12 | 2 | 2.81 | 0.38 | 82515 | G60898-0032 | 7254-0015 |

*O-Ring not included.

*N = flange size

EQUIPMENT
HOSE/CPLG. SELECTION
TECH. DATA
EXT. & VERY HIGH PRESS. HOSE
GS CPLGS.
PCM CPLGS.
PCS CPLGS.
HIGH & MED. PRESS. HOSE
MEGACRIMP® CPLGS.
PC CPLGS.
FIELD ATTACHABLE CPLGS.
AIR BRAKE HOSE & CPLGS.
MEGATECH™ C5 HOSE & CPLGS.
LOW PRESS. HOSE & CPLGS.
C14 HOSE & CPLGS.
POLARSEAL® HOSE & CPLGS.
PWR. STG. HOSE & CPLGS.
THERMO-PLASTIC HOSE & CPLGS.
ADAPTERS
QUICK DISCONNECT CPLGS.
ACCESSORIES & ASSORTMENTS
PART NUMBER INDEXES

Adapters — SAE to SAE – G60 Series

For use up to SAE 100R2 maximum working pressure.

Code 61 O-Ring Flange to Male JIC 37° Flare – High Pressure† – 45°

(No braze joints, solid one-piece construction for increased reliability)

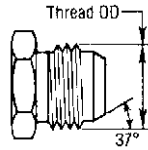

JIC 37° Male (MJ, MJLN)

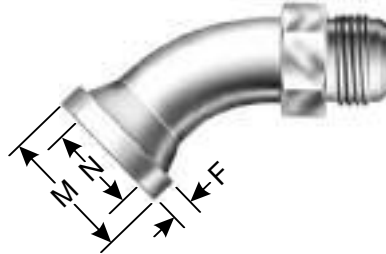

| Descr | # | | | 🌀 | N | M | F | O-Ring* # | | |
|---------------|-------|-------------|------------|-----------|-------|------|------|-----------|-------------|-----------|
| | | | | | " | " | " | | | |
| 12FL5K-12MJ45 | 87995 | G60906-1212 | 7253-13105 | 1-1/16-12 | 3/4 | 1.50 | 0.27 | 82511 | G60898-0012 | 7254-0007 |
| 16FL5K-16MJ45 | 87962 | G60906-1616 | 7253-13125 | 1-5/16-12 | 1 | 1.75 | 0.32 | 82512 | G60898-0016 | 7254-0009 |
| 20FL4K-16MJ45 | --- | G60906-2016 | 7253-12625 | 1-5/16-12 | 1 | 2.00 | 0.32 | 82513 | G60898-0020 | 7254-0011 |
| 20FL4K-20MJ45 | 88012 | G60906-2020 | 7253-12395 | 1-5/8-12 | 1-1/4 | 2.00 | 0.32 | 82513 | G60898-0020 | 7254-0011 |

*O-Ring not included.

*N = flange size

†FL5K maximum working pressure is 5,000 psi; FL4K maximum working pressure is 4,000 psi.

Code 61 O-Ring Flange to Male JIC 37° Flare – 90°

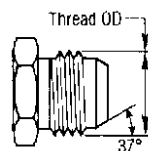

JIC 37° Male (MJ, MJLN)

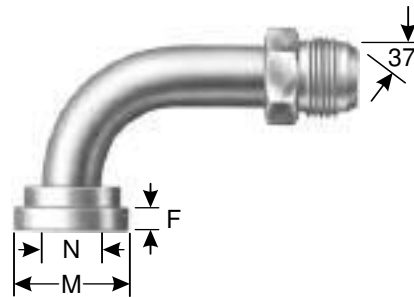

| Descr | # | | | 🌀 | N | M | F | O-Ring* # | | |
|-------------|-------|-------------|------------|-----------|-------|------|------|-----------|-------------|-----------|
| | | | | | " | " | " | | | |
| 8FL-8MJ90 | 86944 | G60910-0808 | 7253-86944 | 3/4-16 | 1/2 | 1.19 | 0.27 | 82510 | G60898-0008 | 7254-0001 |
| 12FL-12MJ90 | 86945 | G60910-1212 | 7253-86945 | 1-1/16-12 | 3/4 | 1.50 | 0.27 | 82511 | G60898-0012 | 7254-0007 |
| 16FL-16MJ90 | 86946 | G60910-1616 | 7253-86946 | 1-5/16-12 | 1 | 1.75 | 0.32 | 82512 | G60898-0016 | 7254-0009 |
| 20FL-20MJ90 | 86947 | G60910-2020 | 7253-86947 | 1-5/8-12 | 1-1/4 | 2.00 | 0.32 | 82513 | G60898-0020 | 7254-0011 |
| 24FL-24MJ90 | 86948 | G60910-2424 | 7253-86948 | 1-7/8-12 | 1-1/2 | 2.38 | 0.32 | 82514 | G60898-0024 | 7254-0013 |
| 32FL-32MJ90 | 86949 | G60910-3232 | 7253-86949 | 2-1/2-12 | 2 | 2.81 | 0.38 | 82515 | G60898-0032 | 7254-0015 |

*O-Ring not included.

*N = flange size

EQUIPMENT

HOSE/CPLG. SELECTION

TECH. DATA

EXT. & VERY HIGH PRESS. HOSE

GS CPLGS.

PCM CPLGS.

PCS CPLGS.

HIGH & MED. PRESS. HOSE

MEGACRIMP® CPLGS.

PC CPLGS.

FIELD ATTACHABLE CPLGS.

AIR BRAKE HOSE & CPLGS.

MEGATECH™ C5 HOSE & CPLGS.

LOW PRESS. HOSE & CPLGS.

C14 HOSE & CPLGS.

POLARSEAL® HOSE & CPLGS.

PWR. STG. HOSE & CPLGS.

THERMO-PLASTIC HOSE & CPLGS.

ADAPTERS

QUICK DISCONNECT CPLGS.

ACCESSORIES & ASSORTMENTS

PART NUMBER INDEXES



The World's Most Trusted Name in Belts, Hose and Hydraulics.

www.gates.com

L63

Adapters — SAE to SAE – G60 Series

For use up to SAE 100R2 maximum working pressure.

Code 61 O-Ring Flange to Male JIC 37° Flare – High Pressure† – 90°

(No braze joints, solid one-piece construction for increased reliability)

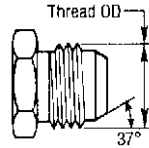

JIC 37° Male (MJ, MJLN)

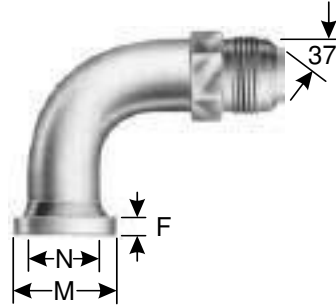

| Descr | # | | | 🌀 | N | M | F | O-Ring* # | | |
|---------------|-------|-------------|------------|-----------|-------|------|------|-----------|-------------|-----------|
| | | | | | " | " | " | | | |
| 12FL5K-12MJ90 | 87963 | G60911-1212 | 7253-13205 | 1-1/16-12 | 3/4 | 1.50 | 0.27 | 82511 | G60898-0012 | 7254-0007 |
| 16FL5K-12MJ90 | 87996 | G60911-1612 | 7253-12415 | 1-1/16-12 | 1 | 1.75 | 0.32 | 82512 | G60898-0016 | 7254-0009 |
| 16FL5K-16MJ90 | 87964 | G60911-1616 | 7253-13225 | 1-5/16-12 | 1 | 1.75 | 0.32 | 82512 | G60898-0016 | 7254-0009 |
| 20FL4K-16MJ90 | 88020 | G60911-2016 | 7253-12495 | 1-5/16-12 | 1-1/4 | 2.00 | 0.32 | 82513 | G60898-0020 | 7254-0011 |
| 20FL4K-20MJ90 | 88013 | G60911-2020 | 7253-12505 | 1-5/8-12 | 1-1/4 | 2.00 | 0.32 | 82513 | G60898-0020 | 7254-0011 |

*O-Ring not included.

*N = flange size

†FL5K maximum working pressure is 5,000 psi; FL4K maximum working pressure is 4,000 psi.

Code 61 O-Ring Flange to Male Flat-Face O-Ring – High Pressure†

(No braze joints, solid one-piece construction for increased reliability)

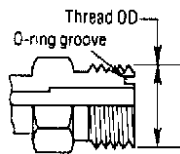

Male Flat-Face O-Ring (MFFOR)

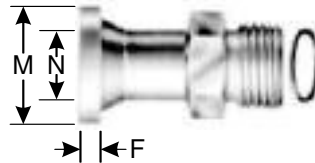

| Descr | # | | | 🌀 | N | M | F | FL O-Ring* | | FFOR O-Ring* | | | |
|----------------|-------|-------------|------------|------------|-------|------|------|------------|-------------|--------------|-------|-------------|-----------|
| | | | | | " | " | " | | | | | | |
| 12FL5K-12MFFOR | 87834 | G60915-1212 | 7253-13695 | 1-3/16-12 | 3/4 | 1.50 | 0.27 | 82511 | G60898-0012 | 7254-0007 | 82564 | G60698-0012 | 7254-0129 |
| 16FL5K-16MFFOR | 87835 | G60915-1616 | 7253-13705 | 1-7/16-12 | 1-1/4 | 2.00 | 0.32 | 82513 | G60898-0020 | 7254-0011 | 82566 | G60698-0020 | 7254-0131 |
| 20FL4K-20MFFOR | 88017 | G60915-2020 | 7253-13715 | 1-1/4 | 1-1/4 | 2.00 | 0.32 | 82513 | G60898-0020 | 7254-0011 | 82566 | G60698-0020 | 7254-0131 |
| 24FL3K-20MFFOR | — | G60915-2420 | 7253-17175 | 1-11/16-12 | 1-1/2 | 2.38 | 0.32 | 82514 | G60898-0004 | 7254-0013 | 82567 | G60698-0024 | 7254-0132 |

*O-Ring not included.

*N = flange size

†FL5K maximum working pressure is 5,000 psi; FL4K maximum working pressure is 4,000 psi.

Adapters — SAE to SAE – G60 Series

For use up to SAE 100R2 maximum working pressure.

Code 61 O-Ring Flange to Male Flat-Face O-Ring – High Pressure[†] – 45°

(No braze joints, solid one-piece construction for increased reliability)

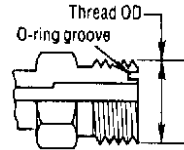

Male Flat-Face O-Ring (MFFOR)

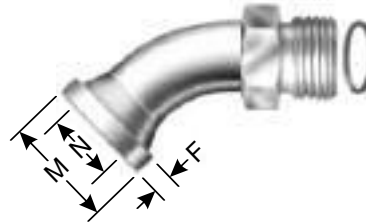

| Descr | # | | | O-Ring Groove | N | M | F | FL O-Ring* | | | FFOR O-Ring* | | |
|------------------|-------|-------------|------------|---------------|-------|------|------|------------|-------------|-----------|--------------|-------------|-----------|
| | | | | | | | | " | " | " | " | " | " |
| 12FL5K-12MFFOR45 | 87836 | G60920-1212 | 7253-13725 | 1-3/16-12 | 3/4 | 1.50 | 0.27 | 82511 | G60898-0012 | 7254-0007 | 82564 | G60698-0012 | 7254-0129 |
| 16FL5K-16MFFOR45 | 87837 | G60920-1616 | 7253-13735 | 1-7/16-12 | 1 | 1.75 | 0.32 | 82512 | G60898-0016 | 7254-0009 | 82565 | G60698-0016 | 7254-0130 |
| 20FL4K-20MFFOR45 | 88018 | G60920-2020 | 7253-13745 | 1-11/6-12 | 1-1/4 | 2.00 | 0.32 | 82513 | G60898-0020 | 7254-0011 | 82566 | G60698-0020 | 7254-0131 |

*O-Ring not included.

*N = flange size

†FL5K maximum working pressure is 5,000 psi; FL4K maximum working pressure is 4,000 psi.

Code 61 O-Ring Flange to Male Flat-Face O-Ring – High Pressure[†] – 90°

(No braze joints, solid one-piece construction for increased reliability)

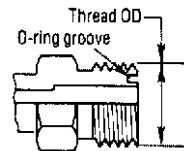

Male Flat-Face O-Ring (MFFOR)

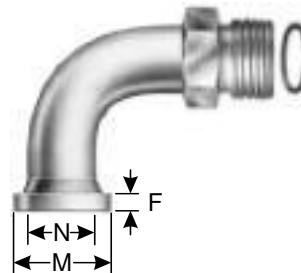

| Descr | # | | | O-Ring Groove | N | M | F | FL O-Ring* | | | FFOR O-Ring* | | |
|------------------|-------|-------------|------------|---------------|-------|------|------|------------|-------------|-----------|--------------|-------------|-----------|
| | | | | | | | | " | " | " | " | " | " |
| 12FL5K-12MFFOR90 | 87838 | G60925-1212 | 7253-13755 | 1-3/16-12 | 3/4 | 1.50 | 0.27 | 82511 | G60898-0012 | 7254-0007 | 82564 | G60698-0012 | 7254-0129 |
| 16FL5K-16MFFOR90 | 87839 | G60925-1616 | 7253-13765 | 1-7/16-12 | 1 | 1.50 | 0.32 | 82512 | G60898-0016 | 7254-0009 | 82565 | G60698-0016 | 7254-0130 |
| 20FL4K-20MFFOR90 | 88019 | G60925-2020 | 7253-13775 | 1-1/4 | 1-1/4 | 2.00 | 0.32 | 82513 | G60898-0020 | 7254-0011 | 82566 | G60698-0020 | 7254-0131 |
| 24FL3K-20MFFOR90 | - | G60925-2420 | 7253-17205 | 1-11/16-12 | 1-1/2 | 2.40 | 0.32 | 82514 | G60898-0024 | 7254-0013 | 82567 | G60698-0024 | 7254-0132 |

*O-Ring not included.

*N = flange size

†FL5K maximum working pressure is 5,000 psi; FL4K maximum working pressure is 4,000 psi.

EQUIPMENT

HOSE/CPLG. SELECTION

TECH. DATA

EXT. & VERY HIGH PRESS. HOSE

GS CPLGS.

PCM CPLGS.

PCS CPLGS.

HIGH & MED. PRESS. HOSE

MEGACRIMP® CPLGS.

PC CPLGS.

FIELD ATTACHABLE CPLGS.

AIR BRAKE HOSE & CPLGS.

MEGATECH® C5 HOSE & CPLGS.

LOW PRESS. HOSE & CPLGS.

C14 HOSE & CPLGS.

POLARSEAL® HOSE & CPLGS.

PWR. STG. HOSE & CPLGS.

THERMO-PLASTIC HOSE & CPLGS.

ADAPTERS

QUICK DISCONNECT CPLGS.

ACCESSORIES & ASSORTMENTS

PART NUMBER INDEXES



The World's Most Trusted Name in Belts, Hose and Hydraulics.

www.gates.com

L65

Adapters — SAE to SAE – G60 Series

For use up to SAE 100R2 maximum working pressure.

Code 61 O-Ring Flange Heavy to DIN Male 24° Inverted Flare – 90° Bent Tube

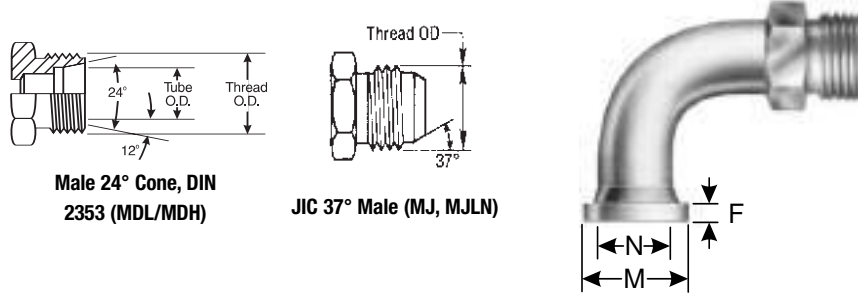

Male 24° Cone, DIN 2353 (MDL/MDH)

JIC 37° Male (MJ, MJLN)

| Descr | # | M36X2.0 | N | M | F | FL O-Ring* | | | FFOR O-Ring* | | |
|----------------|-------------|------------|---|------|-------|------------|-------------|-----------|--------------|-----------|-----------|
| | | | " | " | " | | | | | | |
| 16FL5K-25MDH90 | G63911-1625 | 7253-15755 | 1 | 1.75 | 0.315 | 82512 | G60898-0016 | 7254-0009 | 82565 | G60698-00 | 7254-0130 |

*O-Ring not included.

*N = flange size

†FL4K maximum working pressure is 4,000 psi.

Code 62 O-Ring Flange Cap

Note: For maintenance use only. Not to be used under pressure.

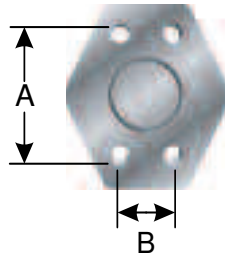

| Descr | # | A" | B" | |
|-----------|-------------|------------|------|------|
| 12FLH-CAP | G60927-0012 | 7253-66165 | 2.00 | 0.41 |
| 16FLH-CAP | G60927-0016 | 7253-66175 | 2.25 | 0.47 |
| 20FLH-CAP | G60927-0020 | 7253-66185 | 2.63 | 0.53 |
| 24FLH-CAP | G60927-0024 | 7253-66195 | 3.13 | 0.66 |
| 32FLH-CAP | G60927-0032 | 7253-66205 | 3.81 | 0.78 |

Flange Half Sets (Code 62 – SAE J518)

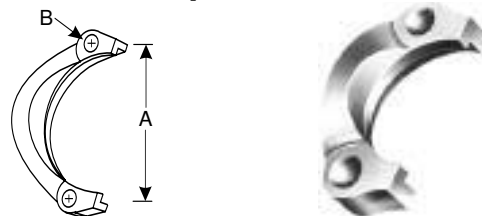

| Descr | # | N" | A" | B" | | |
|--------|-------|-------------|------------|-------|------|------|
| 8FHHS | 87975 | G60929-0008 | 7253-09775 | 1/2 | 1.55 | 0.34 |
| 12FHHS | 87976 | G60929-0012 | 7253-09785 | 3/4 | 2.00 | 0.41 |
| 16FHHS | 87977 | G60929-0016 | 7253-09795 | 1 | 2.25 | 0.47 |
| 20FHHS | 87978 | G60929-0020 | 7253-09805 | 1-1/4 | 2.63 | 0.53 |
| 24FHHS | 87979 | G60929-0024 | 7253-09815 | 1-1/2 | 3.13 | 0.66 |
| 32FHHS | 87980 | G60929-0032 | 7253-09825 | 2 | 3.81 | 0.78 |

Adapters – SAE to SAE – G60 Series

For use up to SAE 100R2 maximum working pressure.

Code 62 O-Ring Flange Heavy to Male JIC 37° Flare (6,000 psi)

(No braze joints, solid one-piece construction for increased reliability)

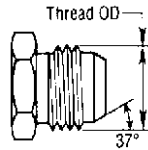

JIC 37° Male (MJ, MJLN)

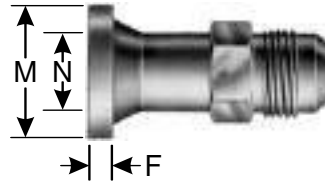

| Descr | # | | | N | M | F | O-Ring* # | | | |
|--------------|-------|-------------|------------|-----------|-------|------|-----------|-------|-------------|-----------|
| | | | | | | | | | | |
| 12FLH6K-12MJ | 87965 | G60930-1212 | 7253-13305 | 1-1/16-12 | 3/4 | 1.63 | 0.35 | 82511 | G60898-0012 | 7254-0007 |
| 16FLH6K-12MJ | 87997 | G60930-1612 | 7253-12445 | 1-1/16-12 | 1 | 1.88 | 0.38 | 82512 | G60898-0016 | 7254-0009 |
| 16FLH6K-16MJ | 87966 | G60930-1616 | 7253-13325 | 1-5/16-12 | 1 | 1.88 | 0.38 | 82512 | G60898-0016 | 7254-0009 |
| 16FLH6K-20MJ | 87998 | G60930-1620 | 7253-12465 | 1-5/8-12 | 1 | 1.88 | 0.38 | 82512 | G60898-0016 | 7254-0009 |
| 20FLH6K-16MJ | 87999 | G60930-2016 | 7253-12515 | 1-5/16-12 | 1-1/4 | 2.13 | 0.41 | 82513 | G60898-0020 | 7254-0011 |
| 20FLH6K-20MJ | 87967 | G60930-2020 | 7253-13345 | 1-5/8-12 | 1-1/4 | 2.13 | 0.41 | 82513 | G60898-0020 | 7254-0011 |
| 24FLH6K-20MJ | - | G60930-2420 | 7253-13375 | 1-5/8-12 | 1-1/2 | 2.50 | 0.50 | 82514 | G60898-0024 | 7254-0013 |
| 24FLH6K-24MJ | 88000 | G60930-2424 | 7253-13365 | 1-7/8-12 | 1-1/2 | 2.50 | 0.50 | 82514 | G60898-0024 | 7254-0013 |

*O-Ring not included.

*N = flange size

Code 62 O-Ring Flange Heavy to Male JIC 37° Flare – 45° (6,000 psi)

(No braze joints, solid one-piece construction for increased reliability)

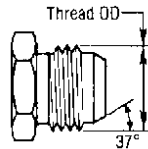

JIC 37° Male (MJ, MJLN)

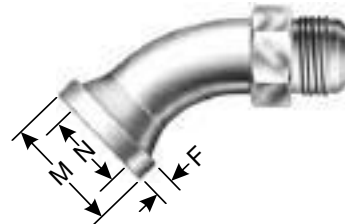

| Descr | # | | | N | M | F | O-Ring* # | | | |
|----------------|-------|-------------|------------|-----------|-------|------|-----------|-------|-------------|-----------|
| | | | | | | | | | | |
| 12FLH6K-12MJ45 | 87968 | G60935-1212 | 7253-13405 | 1-1/16-12 | 3/4 | 1.63 | 0.35 | 82511 | G60898-0012 | 7254-0007 |
| 16FLH6K-16MJ45 | 87969 | G60935-1616 | 7253-13425 | 1-5/16-12 | 1 | 1.88 | 0.38 | 82512 | G60898-0016 | 7254-0009 |
| 20FLH6K-20MJ45 | 88001 | G60935-2020 | 7253-13445 | 1-5/8-12 | 1-1/4 | 2.13 | 0.41 | 82513 | G60898-0020 | 7254-0011 |

*O-Ring not included.

*N = flange size

EQUIPMENT

HOSE/CPLG. SELECTION

TECH. DATA

EXT. & VERY HIGH PRESS. HOSE

GS CPLGS.

PCM CPLGS.

PCS CPLGS.

HIGH & MED. PRESS. HOSE

MEGACRIMP® CPLGS.

PC CPLGS.

FIELD ATTACHABLE CPLGS.

AIR BRAKE HOSE & CPLGS.

MEGATECH® C5 HOSE & CPLGS.

LOW PRESS. HOSE & CPLGS.

C14 HOSE & CPLGS.

POLARSEAL® HOSE & CPLGS.

PWR. STG. HOSE & CPLGS.

THERMO-PLASTIC HOSE & CPLGS.

ADAPTERS

QUICK DISCONNECT CPLGS.

ACCESSORIES & ASSORTMENTS

PART NUMBER INDEXES



The World's Most Trusted Name in Belts, Hose and Hydraulics.

www.gates.com

L67

Adapters — SAE to SAE – G60 Series

For use up to SAE 100R2 maximum working pressure.

Code 62 O-Ring Flange Heavy to Male JIC 37° Flare – 90° (6,000 psi)

(No braze joints, solid one-piece construction for increased reliability)

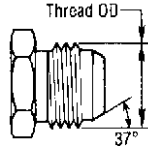

JIC 37° Male (MJ, MJLN)

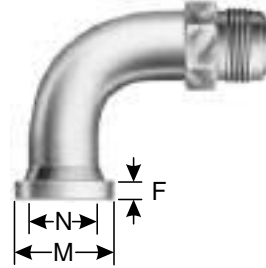

| Descr | # | | | 🌀 | N | M | F | O-Ring* # | | |
|----------------|-------|-------------|------------|-----------|-------|------|------|-----------|-------------|-----------|
| | | | | | " | " | " | | | |
| 12FLH6K-12MJ90 | 87970 | G60940-1212 | 7253-13505 | 1-1/16-12 | 3/4 | 1.63 | 0.35 | 82511 | G60898-0012 | 7254-0007 |
| 12FLH6K-16MJ90 | 87971 | G60940-1216 | 7253-13515 | 1-5/16-12 | 3/4 | 1.63 | 0.35 | 82511 | G60898-0012 | 7254-0007 |
| 16FLH6K-12MJ90 | 88002 | G60940-1612 | 7253-12455 | 1-1/16-12 | 1 | 1.88 | 0.38 | 82512 | G60898-0016 | 7254-0009 |
| 16FLH6K-16MJ90 | 87972 | G60940-1616 | 7253-13535 | 1-5/16-12 | 1 | 1.88 | 0.38 | 82512 | G60898-0016 | 7254-0009 |
| 16FLH6K-20MJ90 | 87973 | G60940-1620 | 7253-13545 | 1-5/8-12 | 1 | 1.88 | 0.38 | 82512 | G60898-0016 | 7254-0009 |
| 20FLH6K-16MJ90 | 88003 | G60940-2016 | 7253-12525 | 1-5/16-12 | 1-1/4 | 2.13 | 0.41 | 82513 | G60898-0020 | 7254-0011 |
| 20FLH6K-20MJ90 | 87974 | G60940-2020 | 7253-13565 | 1-5/8-12 | 1-1/4 | 2.13 | 0.41 | 82513 | G60898-0020 | 7254-0011 |
| 24FLH6K-20MJ90 | 86950 | G60940-2420 | 7253-13575 | 1-5/8-12 | 1-1/2 | 2.50 | 0.50 | 82514 | G60898-0024 | 7254-0013 |

*O-Ring not included.

*N = flange size

Code 62 O-Ring Flange Heavy to Male Flat-Face O-Ring (6,000 psi)

(No braze joints, solid one-piece construction for increased reliability)

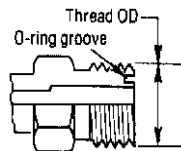

Male Flat-Face O-Ring (MFFOR)

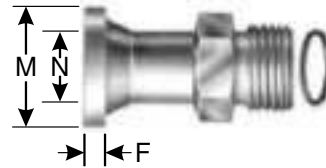

| Descr | # | | | 🌀 | N | M | F | FL O-Ring* # | | | FFOR O-Ring* # | | |
|------------------|-------|-------------|------------|------------|-------|------|------|--------------|-------------|-----------|----------------|-------------|-----------|
| | | | | | " | " | " | | | | | | |
| 12FLH6K-12MFFOR | 87810 | G60945-1212 | 7253-13605 | 1-3/16-12 | 3/4 | 1.63 | 0.35 | 82511 | G60898-0012 | 7254-0007 | 82564 | G60698-0012 | 7254-0129 |
| 16FLH6K-16MFFOR | 87811 | G60945-1616 | 7253-13615 | 1-7/16-12 | 1 | 1.88 | 0.38 | 82512 | G60898-0016 | 7254-0009 | 82565 | G60698-0016 | 7254-0130 |
| †20FLH4K-20MFFOR | 88014 | G60945-2020 | 7253-13625 | 1-11/16-12 | 1-1/4 | 2.13 | 0.41 | 82513 | G60898-0020 | 7254-0011 | 82566 | G60698-0020 | 7254-0131 |
| 24FLH4K-20MFFOR | — | G60915-2420 | 7253-17275 | 1-11/16-12 | 1-1/2 | 2.50 | 0.49 | 82514 | G60898-0004 | 7254-0013 | 82567 | G60698-0024 | 7254-0132 |

*O-Ring not included.

*N = flange size

†FL4K maximum working pressure is 4,000 psi.



Code 62 O-Ring Flange Heavy to Male Flat-Face O-Ring – 45° (6,000 psi)

(No braze joints, solid one-piece construction for increased reliability)

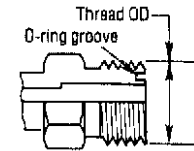

Male Flat-Face O-Ring (MFFOR)

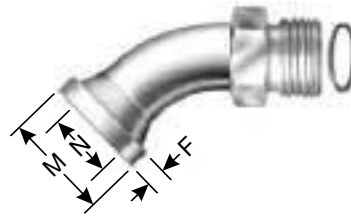

| Descr | # | | | O-ring groove | N | M | F | FL O-Ring* # | | | FFOR O-Ring* # | | |
|--------------------|-------|-------------|------------|---------------|-------|------|------|--------------|-------------|-----------|----------------|-------------|-----------|
| | | | | | " | " | " | | | | | | |
| 12FLH6K-12MFFOR45 | 87812 | G60950-1212 | 7253-13635 | 1-3/16-12 | 3/4 | 1.63 | 0.35 | 82511 | G60898-0012 | 7254-0007 | 82564 | G60698-0012 | 7254-0129 |
| 16FLH6K-16MFFOR45 | 87813 | G60950-1616 | 7253-13645 | 1-7/16-12 | 1 | 1.88 | 0.38 | 82512 | G60898-0016 | 7254-0009 | 82565 | G60698-0016 | 7254-0130 |
| †20FLH4K-20MFFOR45 | 88015 | G60950-2020 | 7253-13655 | 1-11/16-12 | 1-1/4 | 2.13 | 0.41 | 82513 | G60898-0020 | 7254-0011 | 82566 | G60698-0020 | 7254-0131 |

*O-Ring not included.

*N = flange size

†FL4K maximum working pressure is 4,000 psi.

Code 62 O-Ring Flange Heavy to Male Flat-Face O-Ring – 90° (6,000 psi)

(No braze joints, solid one-piece construction for increased reliability)

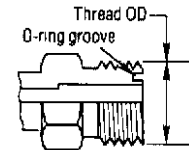

Male Flat-Face O-Ring (MFFOR)

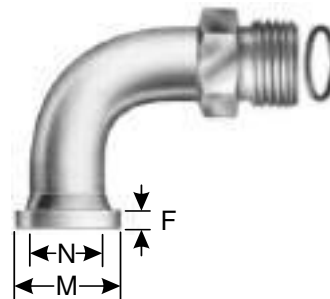

| Descr | # | | | O-ring groove | N | M | F | FL O-Ring* # | | | FFOR O-Ring* # | | |
|--------------------|-------|-------------|------------|---------------|-------|------|------|--------------|-------------|-----------|----------------|-------------|-----------|
| | | | | | " | " | " | | | | | | |
| 12FLH6K-12MFFOR90 | 87814 | G60955-1212 | 7253-13665 | 1-3/16-12 | 3/4 | 1.63 | 0.35 | 82511 | G60898-0012 | 7254-0007 | 82564 | G60698-0012 | 7254-0129 |
| 16FLH6K-12MFFOR90 | - | G60955-1612 | 7253-13465 | 1-3/16-12 | 1 | 1.88 | 0.38 | 82512 | G60898-0016 | 7254-0009 | 82565 | G60698-0016 | 7254-0130 |
| 16FLH6K-16MFFOR90 | 87815 | G60955-1616 | 7253-13675 | 1-7/16-12 | 1 | 1.88 | 0.38 | 82512 | G60898-0016 | 7254-0009 | 82565 | G60698-0016 | 7254-0130 |
| †20FLH4K-20MFFOR90 | 88016 | G60955-2020 | 7253-13685 | 1-11/16-12 | 1-1/4 | 2.13 | 0.41 | 82513 | G60898-0020 | 7254-0011 | 82566 | G60698-0020 | 7254-0131 |
| 24FLH4K-20MFFOR90 | - | G60925-2420 | 7253-17305 | 1-11/16-12 | 1-1/2 | 2.50 | 0.49 | 82514 | G60898-0024 | 7254-0013 | 82567 | G60698-0024 | 7254-0132 |

*O-Ring not included.

*N = flange size

†FL4K maximum working pressure is 4,000 psi.

| |
|------------------------------|
| EQUIPMENT |
| HOSE/CPLG. SELECTION |
| TECH. DATA |
| EXT. & VERY HIGH PRESS. HOSE |
| GS CPLGS. |
| PCM CPLGS. |
| PCS CPLGS. |
| HIGH & MED. PRESS. HOSE |
| MEGACRIMP® CPLGS. |
| PC CPLGS. |
| FIELD ATTACHABLE CPLGS. |
| AIR BRAKE HOSE & CPLGS. |
| MEGATECH® C5 HOSE & CPLGS. |
| LOW PRESS. HOSE & CPLGS. |
| C14 HOSE & CPLGS. |
| POLARSEAL® HOSE & CPLGS. |
| PWR. STG. HOSE & CPLGS. |
| THERMO-PLASTIC HOSE & CPLGS. |
| ADAPTERS |
| QUICK DISCONNECT CPLGS. |
| ACCESSORIES & ASSORTMENTS |
| PART NUMBER INDEXES |



Adapters — British to SAE — G62 Series

British to SAE

Male British Standard Pipe Tapered Thread to Male JIC 37° Flare

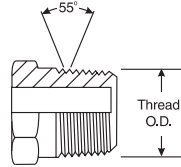

BSPT Male (MBSPT)

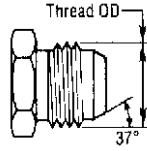

JIC 37° Male (MJ, MJLN)



| Descr | # | | |  | |
|--------------|-------------|-------------|------------|---|-----------|
| | | | | MBSPT | MJ |
| 2MBSPT-4MJ | 88023 | G62150-0204 | 7253-14255 | 1/8-28 | 7/16-20 |
| 2MBSPT-5MJ | G62150-0205 | G62150-0205 | 7253-60005 | 1/8-28 | 1/2-20 |
| 2MBSPT-6MJ | G62150-0206 | G62150-0206 | 7253-60015 | 1/8-28 | 9/16-18 |
| 4MBSPT-4MJ | 88024 | G62150-0404 | 7253-14265 | 1/4-19 | 7/16-20 |
| 4MBSPT-5MJ | G62150-0405 | G62150-0405 | 7253-60025 | 1/4-19 | 1/2-20 |
| 4MBSPT-6MJ | G62150-0406 | G62150-0406 | 7253-60035 | 1/4-19 | 9/16-18 |
| 4MBSPT-8MJ | G62150-0408 | G62150-0408 | 7253-60045 | 1/4-19 | 3/4-16 |
| 6MBSPT-4MJ | G62150-0604 | G62150-0604 | 7253-60055 | 3/8-19 | 7/16-20 |
| 6MBSPT-5MJ | G62150-0605 | G62150-0605 | 7253-60065 | 3/8-19 | 1/2-20 |
| 6MBSPT-6MJ | 88025 | G62150-0606 | 7253-14275 | 3/8-19 | 9/16-18 |
| 6MBSPT-8MJ | G62150-0608 | G62150-0608 | 7253-60075 | 3/8-19 | 3/4-16 |
| 6MBSPT-10MJ | G62150-0610 | G62150-0610 | 7253-60085 | 3/8-19 | 7/8-14 |
| 8MBSPT-6MJ | G62150-0806 | G62150-0806 | 7253-60095 | 1/2-14 | 9/16-18 |
| 8MBSPT-8MJ | 88026 | G62150-0808 | 7253-14285 | 1/2-14 | 3/4-16 |
| 8MBSPT-10MJ | 88027 | G62150-0810 | 7253-14295 | 1/2-14 | 7/8-14 |
| 8MBSPT-12MJ | G62150-0812 | G62150-0812 | 7253-60105 | 1/2-14 | 1 1/16-12 |
| 12MBSPT-8MJ | G62150-1208 | G62150-1208 | 7253-60115 | 3/4-14 | 3/4-16 |
| 12MBSPT-10MJ | G62150-1210 | G62150-1210 | 7253-60125 | 3/4-14 | 7/8-14 |
| 12MBSPT-12MJ | 88028 | G62150-1212 | 7253-14305 | 3/4-14 | 1-1/16-12 |
| 12MBSPT-14MJ | G62150-1214 | G62150-1214 | 7253-60135 | 3/4-14 | 1 3/16-12 |
| 12MBSPT-16MJ | G62150-1216 | G62150-1216 | 7253-60145 | 3/4-14 | 1 5/16-12 |
| 16MBSPT-12MJ | G62150-1612 | G62150-1612 | 7253-60155 | 1-11 | 1 1/16-12 |
| 16MBSPT-16MJ | 88029 | G62150-1616 | 7253-14315 | 1-11 | 1-5/16-12 |
| 16MBSPT-20MJ | G62150-1620 | G62150-1620 | 7253-60165 | 1-11 | 1 5/8-12 |
| 20MBSPT-16MJ | G62150-2016 | G62150-2016 | 7253-60175 | 1 1/4-11 | 1 5/16-12 |
| 20MBSPT-20MJ | G62150-2020 | G62150-2020 | 7253-60185 | 1 1/4-11 | 1 5/8-12 |
| 24MBSPT-24MJ | G62150-2424 | G62150-2424 | 7253-60195 | 1 1/2-11 | 1 7/8-12 |
| 32MBSPT-32MJ | G62150-3232 | G62150-3232 | 7253-60205 | 2-11 | 2 1/2-12 |

EQUIPMENT
HOSE/CPLG. SELECTION
TECH. DATA
EXT. & VERY HIGH PRESS. HOSE
GS CPLGS.
PCM CPLGS.
PCS CPLGS.
HIGH & MED. PRESS. HOSE
MEGACRIMP® CPLGS.
PC CPLGS.
FIELD ATTACHABLE CPLGS.
AIR BRAKE HOSE & CPLGS.
MEGATECH™ C5 HOSE & CPLGS.
LOW PRESS. HOSE & CPLGS.
C14 HOSE & CPLGS.
POLARSEAL® HOSE & CPLGS.
PWR. STG. HOSE & CPLGS.
THERMO-PLASTIC HOSE & CPLGS.
ADAPTERS
QUICK DISCONNECT CPLGS.
ACCESSORIES & ASSORTMENTS
PART NUMBER INDEXES



Adapters — British to SAE — G62 Series

Male British Standard Pipe Tapered Thread to Male JIC 37° Flare – 45°

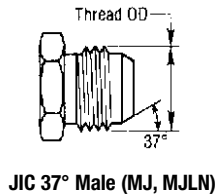
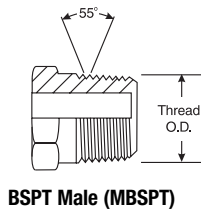

| Descr | # | |  | |
|----------------|-------------|------------|---|-----------|
| | | | MBSPT | MJ |
| 2MBSPT-4MJ45 | G62153-0204 | 7253-60215 | 1/8-28 | 7/16-20 |
| 4MBSPT-4MJ45 | G62153-0404 | 7253-60225 | 1/4-19 | 7/16-20 |
| 4MBSPT-6MJ45 | G62153-0406 | 7253-60235 | 1/4-19 | 9/16-18 |
| 6MBSPT-6MJ45 | G62153-0606 | 7253-60245 | 3/8-19 | 9/16-18 |
| 6MBSPT-8MJ45 | G62153-0608 | 7253-60255 | 3/8-19 | 3/4-16 |
| 8MBSPT-8MJ45 | G62153-0808 | 7253-60265 | 1/2-14 | 3/4-16 |
| 8MBSPT-10MJ45 | G62153-0810 | 7253-60275 | 1/2-14 | 7/8-14 |
| 12MBSPT-12MJ45 | G62153-1212 | 7253-60285 | 3/4-14 | 1-1/16-12 |
| 12MBSPT-16MJ45 | G62153-1216 | 7253-60295 | 3/4-14 | 1-5/16-12 |
| 16MBSPT-16MJ45 | G62153-1616 | 7253-60305 | 1-11 | 1-5/16-12 |

EQUIPMENT

HOSE/CPLG.
SELECTION

TECH. DATA

EXT. &
VERY HIGH
PRESS. HOSE

GS CPLGS.

PCM CPLGS.

PCS CPLGS.

HIGH & MED.
PRESS. HOSEMEGACRIMP®
CPLGS.

PC CPLGS.

FIELD
ATTACHABLE
CPLGS.AIR BRAKE
HOSE &
CPLGS.MEGATECH®
C5
HOSE &
CPLGS.LOW PRESS.
HOSE &
CPLGS.C14 HOSE
& CPLGS.POLARSEAL®
HOSE &
CPLGS.PWR. STG.
HOSE &
CPLGS.THERMO-
PLASTIC
HOSE &
CPLGS.

ADAPTERS

QUICK
DISCONNECT
CPLGS.ACCESSORIES
& ASSORT-
MENTSPART NUMBER
INDEXES

Adapters — British to SAE — G62 Series

Male British Standard Pipe Tapered Thread to Male JIC 37° Flare – 90°

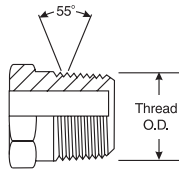

BSPT Male (MBSPT)

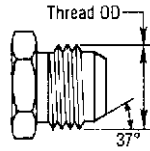

JIC 37° Male (MJ, MJLN)



| Descr | # | |  | |
|----------------|-------------|------------|---|-----------|
| | | | MBSPT | MJ |
| 2MBSPT-4MJ90 | G62155-0204 | 7253-60315 | 1/8-28 | 7/16-20 |
| 4MBSPT-4MJ90 | G62155-0404 | 7253-60325 | 1/4-19 | 7/16-20 |
| 4MBSPT-5MJ90 | G62155-0405 | 7253-60335 | 1/4-19 | 1/2-20 |
| 4MBSPT-6MJ90 | G62155-0406 | 7253-60345 | 1/4-19 | 9/16-18 |
| 6MBSPT-6MJ90 | G62155-0606 | 7253-60355 | 3/8-19 | 9/16-18 |
| 6MBSPT-8MJ90 | G62155-0608 | 7253-60365 | 3/8-19 | 3/4-16 |
| 8MBSPT-6MJ90 | G62155-0806 | 7253-60375 | 1/2-14 | 9/16-18 |
| 8MBSPT-8MJ90 | G62155-0808 | 7253-60385 | 1/2-14 | 3/4-16 |
| 8MBSPT-10MJ90 | G62155-0810 | 7253-60395 | 1/2-14 | 7/8-14 |
| 8MBSPT-12MJ90 | G62155-0812 | 7253-60405 | 1/2-14 | 1-1/16-12 |
| 12MBSPT-12MJ90 | G62155-1212 | 7253-60415 | 3/4-14 | 1-1/16-12 |
| 12MBSPT-16MJ90 | G62155-1216 | 7253-60425 | 3/4-14 | 1-5/16-12 |
| 16MBSPT-16MJ90 | G62155-1616 | 7253-60435 | 1-11 | 1-5/16-12 |
| 20MBSPT-20MJ90 | G62155-2020 | 7253-60445 | 1-1/4-11 | 1-5/8-12 |
| 24MBSPT-24MJ90 | G62155-2424 | 7253-60455 | 1-1/2-11 | 1-7/8-12 |
| 32MBSPT-32MJ90 | G62155-3232 | 7253-60465 | 2-11 | 2-1/2-12 |

EQUIPMENT
HOSE/CPLG. SELECTION
TECH. DATA
EXT. & VERY HIGH PRESS. HOSE
GS CPLGS.
PCM CPLGS.
PCS CPLGS.
HIGH & MED. PRESS. HOSE
MEGACRIMP® CPLGS.
PC CPLGS.
FIELD ATTACHABLE CPLGS.
AIR BRAKE HOSE & CPLGS.
MEGATECH® C5 HOSE & CPLGS.
LOW PRESS. HOSE & CPLGS.
C14 HOSE & CPLGS.
POLARSEAL® HOSE & CPLGS.
PWR. STG. HOSE & CPLGS.
THERMO-PLASTIC HOSE & CPLGS.
ADAPTERS
QUICK DISCONNECT CPLGS.
ACCESSORIES & ASSORTMENTS
PART NUMBER INDEXES

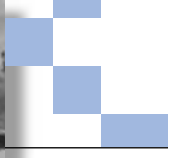

Male British Standard Pipe Parallel to Male Pipe NPTF

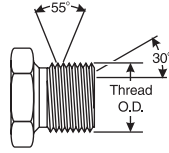

BSPP Male (MBSPP)

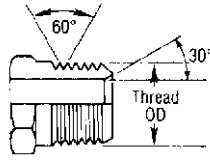

NPTF Solid Male (MP)



| Descr | # | | |  | |
|--------------|-------------|-------------|------------|---|--------------|
| | | | | MBSPP | MP (NPTF) |
| 2MBSPP-2MP | G62200-0202 | G62200-0202 | 7253-60475 | 1/8-28 | 1/8-27 |
| 2MBSPP-4MP | G62200-0204 | G62200-0204 | 7253-60485 | 1/8-28 | 1/4-18 |
| 4MBSPP-2MP | G62200-0402 | G62200-0402 | 7253-60495 | 1/4-19 | 1/8-27 |
| 4MBSPP-4MP | 87906 | G62200-0404 | 7253-15075 | 1/4-19 | 1/4-18 |
| 4MBSPP-6MP | G62200-0406 | G62200-0406 | 7253-60505 | 1/4-19 | 3/8-18 |
| 4MBSPP-8MP | G62200-0408 | G62200-0408 | 7253-60515 | 1/4-19 | 1/2-14 |
| 6MBSPP-2MP | G62200-0602 | G62200-0602 | 7253-60525 | 3/8-19 | 1/8-27 |
| 6MBSPP-4MP | G62200-0604 | G62200-0604 | 7253-60535 | 3/8-19 | 1/4-18 |
| 6MBSPP-6MP | 87907 | G62200-0606 | 7253-15085 | 3/8-19 | 3/8-18 |
| 6MBSPP-8MP | G62200-0608 | G62200-0608 | 7253-60545 | 3/8-19 | 1/2-14 |
| 6MBSPP-12MP | G62200-0612 | G62200-0612 | 7253-60555 | 3/8-19 | 3/4-14 |
| 6MBSPP-16MP | G62200-0616 | G62200-0616 | 7253-60565 | 3/8-19 | 1-11-1/2 |
| 8MBSPP-4MP | G62200-0804 | G62200-0804 | 7253-60575 | 1/2-14 | 1/4-18 |
| 8MBSPP-6MP | G62200-0806 | G62200-0806 | 7253-60585 | 1/2-14 | 3/8-18 |
| 8MBSPP-8MP | 87908 | G62200-0808 | 7253-15095 | 1/2-14 | 1/2-14 |
| 8MBSPP-12MP | G62200-0812 | G62200-0812 | 7253-60595 | 1/2-14 | 3/4-14 |
| 8MBSPP-16MP | G62200-0816 | G62200-0816 | 7253-60605 | 1/2-14 | 1-11-1/2 |
| 10MBSPP-8MP | G62200-1008 | G62200-1008 | 7253-60615 | 5/8-14 | 1/2-14 |
| 10MBSPP-12MP | G62200-1012 | G62200-1012 | 7253-60625 | 5/8-14 | 3/4-14 |
| 12MBSPP-8MP | G62200-1208 | G62200-1208 | 7253-60635 | 3/4-14 | 1/2-14 |
| 12MBSPP-12MP | 87909 | G62200-1212 | 7253-15105 | 3/4-14 | 3/4-14 |
| 12MBSPP-16MP | G62200-1216 | G62200-1216 | 7253-60645 | 3/4-14 | 1-11-1/2 |
| 12MBSPP-20MP | G62200-1220 | G62200-1220 | 7253-60655 | 3/4-14 | 1-1/4-11-1/2 |
| 16MBSPP-12MP | G62200-1612 | G62200-1612 | 7253-60665 | 1-11 | 3/4-14 |
| 16MBSPP-16MP | 87910 | G62200-1616 | 7253-15115 | 1-11 | 1-11-1/2 |
| 16MBSPP-20MP | G62200-1620 | G62200-1620 | 7253-60675 | 1-11 | 1-1/4-11-1/2 |
| 20MBSPP-16MP | G62200-2016 | G62200-2016 | 7253-60685 | 1-1/4-11 | 1-11-1/2 |
| 20MBSPP-20MP | G62200-2020 | G62200-2020 | 7253-60695 | 1-1/4-11 | 1-1/4-11-1/2 |
| 20MBSPP-24MP | G62200-2024 | G62200-2024 | 7253-60705 | 1-1/4-11 | 1-1/2-11-1/2 |
| 24MBSPP-20MP | G62200-2420 | G62200-2420 | 7253-60715 | 1-1/2-11 | 1-1/4-11-1/2 |
| 24MBSPP-24MP | G62200-2424 | G62200-2424 | 7253-60725 | 1-1/2-11 | 1-1/2-11-1/2 |
| 32MBSPP-32MP | G62200-3232 | G62200-3232 | 7253-60735 | 2-11 | 2-11-1/2 |

EQUIPMENT

HOSE/CPLG. SELECTION

TECH. DATA

EXT. & VERY HIGH PRESS. HOSE

GS CPLGS.

PCM CPLGS.

PCS CPLGS.

HIGH & MED. PRESS. HOSE

MEGACRIMP® CPLGS.

PC CPLGS.

FIELD ATTACHABLE CPLGS.

AIR BRAKE HOSE & CPLGS.

MEGATECH® C5 HOSE & CPLGS.

LOW PRESS. HOSE & CPLGS.

C14 HOSE & CPLGS.

POLARSEAL® HOSE & CPLGS.

PWR. STG. HOSE & CPLGS.

THERMO-PLASTIC HOSE & CPLGS.

ADAPTERS

QUICK DISCONNECT CPLGS.

ACCESSORIES & ASSORTMENTS

PART NUMBER INDEXES



Adapters — British to SAE — G62 Series

Male British Standard Pipe Parallel to Female Pipe NPTF

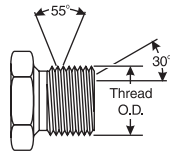

BSPP Male (MBSPP)

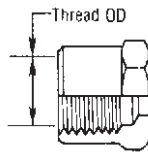

**NPTF or NPSF
Solid Female (FP)**



| Descr | # | |  | |
|--------------|-------------|------------|---|--------------|
| | | | MBSPP | FP (NPTF) |
| 2MBSPP-2FP | G62220-0202 | 7253-60745 | 1/8-28 | 1/8-27 |
| 2MBSPP-4FP | G62220-0204 | 7253-60755 | 1/8-28 | 1/4-18 |
| 4MBSPP-2FP | G62220-0402 | 7253-60765 | 1/4-19 | 1/8-27 |
| 4MBSPP-4FP | G62220-0404 | 7253-60775 | 1/4-19 | 1/4-18 |
| 4MBSPP-6FP | G62220-0406 | 7253-60785 | 1/4-19 | 3/8-18 |
| 6MBSPP-2FP | G62220-0602 | 7253-60795 | 3/8-19 | 1/8-27 |
| 6MBSPP-4FP | G62220-0604 | 7253-60805 | 3/8-19 | 1/4-18 |
| 6MBSPP-6FP | G62220-0606 | 7253-60815 | 3/8-19 | 3/8-18 |
| 8MBSPP-4FP | G62220-0804 | 7253-60825 | 1/2-14 | 1/4-18 |
| 8MBSPP-6FP | G62220-0806 | 7253-60835 | 1/2-14 | 3/8-18 |
| 8MBSPP-8FP | G62220-0808 | 7253-60845 | 1/2-14 | 1/2-14 |
| 12MBSPP-8FP | G62220-1208 | 7253-60855 | 3/4-14 | 1/2-14 |
| 12MBSPP-12FP | G62220-1212 | 7253-60865 | 3/4-14 | 3/4-14 |
| 16MBSPP-16FP | G62220-1616 | 7253-60875 | 1-11 | 1-11-1/2 |
| 20MBSPP-16FP | G62220-2016 | 7253-60885 | 1-1/4-11 | 1-11-1/2 |
| 20MBSPP-20FP | G62220-2020 | 7253-60895 | 1-1/4-11 | 1-1/4-11-1/2 |
| 24MBSPP-20FP | G62220-2420 | 7253-60905 | 1-1/2-11 | 1-1/4-11-1/2 |
| 24MBSPP-24FP | G62220-2424 | 7253-60915 | 1-1/2-11 | 1-1/2-11-1/2 |
| 32MBSPP-32FP | G62220-3232 | 7253-60925 | 2-11 | 2-11-1/2 |

- EQUIPMENT
- HOSE/CPLG. SELECTION
- TECH. DATA
- EXT. & VERY HIGH PRESS. HOSE
- GS CPLGS.
- PCM CPLGS.
- PCS CPLGS.
- HIGH & MED. PRESS. HOSE
- MEGACRIMP® CPLGS.
- PC CPLGS.
- FIELD ATTACHABLE CPLGS.
- AIR BRAKE HOSE & CPLGS.
- MEGATECH™ C5 HOSE & CPLGS.
- LOW PRESS. HOSE & CPLGS.
- C14 HOSE & CPLGS.
- POLARSEAL® HOSE & CPLGS.
- PWR. STG. HOSE & CPLGS.
- THERMO-PLASTIC HOSE & CPLGS.
- ADAPTERS
- QUICK DISCONNECT CPLGS.
- ACCESSORIES & ASSORTMENTS
- PART NUMBER INDEXES

Adapters — British to SAE — G62 Series



Male British Standard Pipe Parallel to Male JIC 37° Flare

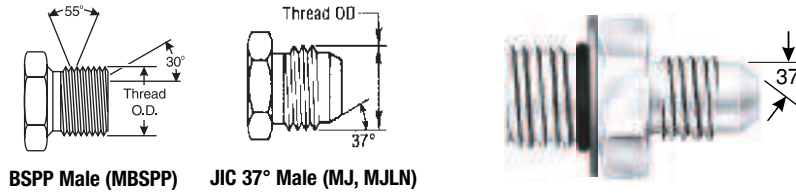

BSPP Male (MBSPP)

JIC 37° Male (MJ, MJLN)

| Descr | # | | |  | |
|--------------|-------------|-------------|------------|---|-----------|
| | | | | MBSPP | MJ |
| 2MBSPP-4MJ | G62300-0204 | G62300-0204 | 7253-60935 | 1/8-28 | 7/16-20 |
| 2MBSPP-5MJ | G62300-0205 | G62300-0205 | 7253-60945 | 1/8-28 | 1/2-20 |
| 2MBSPP-6MJ | G62300-0206 | G62300-0206 | 7253-60955 | 1/8-28 | 9/16-18 |
| 4MBSPP-4MJ | 87900 | G62300-0404 | 7253-15015 | 1/4-19 | 7/16-20 |
| 4MBSPP-5MJ | G62300-0405 | G62300-0405 | 7253-60965 | 1/4-19 | 1/2-20 |
| 4MBSPP-6MJ | G62300-0406 | G62300-0406 | 7253-60975 | 1/4-19 | 9/16-18 |
| 4MBSPP-8MJ | G62300-0408 | G62300-0408 | 7253-60985 | 1/4-19 | 3/4-16 |
| 6MBSPP-4MJ | G62300-0604 | G62300-0604 | 7253-60995 | 3/8-19 | 7/16-20 |
| 6MBSPP-5MJ | G62300-0605 | G62300-0605 | 7253-61005 | 3/8-19 | 1/2-20 |
| 6MBSPP-6MJ | 87901 | G62300-0606 | 7253-15025 | 3/8-19 | 9/16-18 |
| 6MBSPP-8MJ | G62300-0608 | G62300-0608 | 7253-61015 | 3/8-19 | 3/4-16 |
| 8MBSPP-6MJ | G62300-0806 | G62300-0806 | 7253-61025 | 1/2-14 | 9/16-18 |
| 8MBSPP-8MJ | 87902 | G62300-0808 | 7253-15035 | 1/2-14 | 3/4-16 |
| 8MBSPP-10MJ | G62300-0810 | G62300-0810 | 7253-61035 | 1/2-14 | 7/8-14 |
| 8MBSPP-12MJ | G62300-0812 | G62300-0812 | 7253-61045 | 1/2-14 | 1-1/16-12 |
| 10MBSPP-8MJ | G62300-1008 | G62300-1008 | 7253-61055 | 5/8-14 | 3/4-16 |
| 10MBSPP-10MJ | 87903 | G62300-1010 | 7253-15045 | 5/8-14 | 7/8-14 |
| 10MBSPP-12MJ | G62300-1012 | G62300-1012 | 7253-61065 | 5/8-14 | 1-1/16-12 |
| 12MBSPP-8MJ | G62300-1208 | G62300-1208 | 7253-61075 | 3/4-14 | 3/4-16 |
| 12MBSPP-10MJ | G62300-1210 | G62300-1210 | 7253-61085 | 3/4-14 | 7/8-14 |
| 12MBSPP-12MJ | 87904 | G62300-1212 | 7253-15055 | 3/4-14 | 1-1/16-12 |
| 12MBSPP-14MJ | G62300-1214 | G62300-1214 | 7253-61095 | 3/4-14 | 1-3/16-12 |
| 12MBSPP-16MJ | G62300-1216 | G62300-1216 | 7253-61105 | 3/4-14 | 1-5/16-12 |
| 16MBSPP-12MJ | G62300-1612 | G62300-1612 | 7253-61115 | 1-11 | 1-1/16-12 |
| 16MBSPP-14MJ | G62300-1614 | G62300-1614 | 7253-61125 | 1-11 | 1-3/16-12 |
| 16MBSPP-16MJ | 87905 | G62300-1616 | 7253-15065 | 1-11 | 1-5/16-12 |
| 16MBSPP-20MJ | G62300-1620 | G62300-1620 | 7253-61135 | 1-11 | 1-5/8-12 |
| 20MBSPP-16MJ | G62300-2016 | G62300-2016 | 7253-61145 | 1-1/4-11 | 1-5/16-12 |
| 20MBSPP-20MJ | G62300-2020 | G62300-2020 | 7253-61155 | 1-1/4-11 | 1-5/8-12 |
| 20MBSPP-24MJ | G62300-2024 | G62300-2024 | 7253-61165 | 1-1/4-11 | 1-7/8-12 |
| 24MBSPP-20MJ | G62300-2420 | G62300-2420 | 7253-61175 | 1-1/2-11 | 1-5/8-12 |
| 24MBSPP-24MJ | G62300-2424 | G62300-2424 | 7253-61185 | 1-1/2-11 | 1-7/8-12 |
| 32MBSPP-32MJ | G62300-3232 | G62300-3232 | 7253-61195 | 2-11 | 2-1/2-12 |

EQUIPMENT

HOSE/CPLG. SELECTION

TECH. DATA

EXT. & VERY HIGH PRESS. HOSE

GS CPLGS.

PCM CPLGS.

PCS CPLGS.

HIGH & MED. PRESS. HOSE

MEGACRIMP® CPLGS.

PC CPLGS.

FIELD ATTACHABLE CPLGS.

AIR BRAKE HOSE & CPLGS.

MEGATECH® C5 HOSE & CPLGS.

LOW PRESS. HOSE & CPLGS.

C14 HOSE & CPLGS.

POLARSEAL® HOSE & CPLGS.

PWR. STG. HOSE & CPLGS.

THERMO-PLASTIC HOSE & CPLGS.

ADAPTERS

QUICK DISCONNECT CPLGS.

ACCESSORIES & ASSORTMENTS

PART NUMBER INDEXES



Adapters — British to SAE — G62 Series

Male British Standard Pipe Parallel to Male JIC 37° Flare — 45°

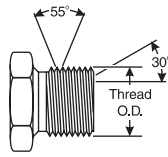

BSPP Male (MBSPP)

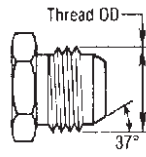

JIC 37° Male (MJ, MJLN)

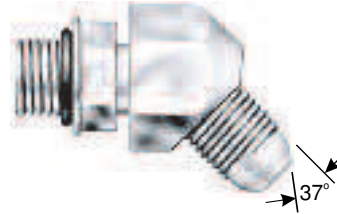

| Descr | # | |  | |
|----------------|-------------|------------|---|-----------|
| | | | MBSPP | MJ |
| 2MBSPP-4MJ45 | G62305-0204 | 7253-61205 | 1/8-28 | 7/16-20 |
| 4MBSPP-4MJ45 | G62305-0404 | 7253-61215 | 1/4-19 | 7/16-20 |
| 4MBSPP-6MJ45 | G62305-0406 | 7253-61225 | 1/4-19 | 9/16-18 |
| 6MBSPP-6MJ45 | G62305-0606 | 7253-61235 | 3/8-19 | 9/16-18 |
| 6MBSPP-8MJ45 | G62305-0608 | 7253-61245 | 3/8-19 | 3/4-16 |
| 8MBSPP-8MJ45 | G62305-0808 | 7253-61255 | 1/2-14 | 3/4-16 |
| 8MBSPP-10MJ45 | G62305-0810 | 7253-61265 | 1/2-14 | 7/8-14 |
| 8MBSPP-12MJ45 | G62305-0812 | 7253-61275 | 1/2-14 | 1-1/16-12 |
| 12MBSPP-12MJ45 | G62305-1212 | 7253-61285 | 3/4-14 | 1-1/16-12 |
| 16MBSPP-16MJ45 | G62305-1616 | 7253-61295 | 1-11 | 1-5/16-12 |

- EQUIPMENT
- HOSE/CPLG. SELECTION
- TECH. DATA
- EXT. & VERY HIGH PRESS. HOSE
- GS CPLGS.
- PCM CPLGS.
- PCS CPLGS.
- HIGH & MED. PRESS. HOSE
- MEGACRIMP® CPLGS.
- PC CPLGS.
- FIELD ATTACHABLE CPLGS.
- AIR BRAKE HOSE & CPLGS.
- MEGATECH™ C5 HOSE & CPLGS.
- LOW PRESS. HOSE & CPLGS.
- C14 HOSE & CPLGS.
- POLARSEAL® HOSE & CPLGS.
- PWR. STG. HOSE & CPLGS.
- THERMO-PLASTIC HOSE & CPLGS.
- ADAPTERS
- QUICK DISCONNECT CPLGS.
- ACCESSORIES & ASSORTMENTS
- PART NUMBER INDEXES



Male British Standard Pipe Parallel to Male JIC 37° Flare – 90°

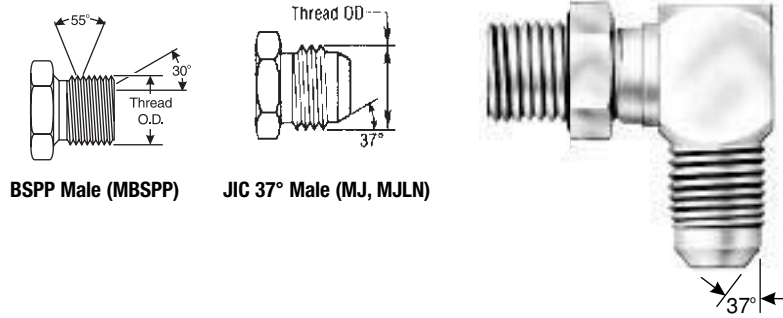

BSPP Male (MBSPP)

JIC 37° Male (MJ, MJLN)

| Descr | # | |  | |
|----------------|-------------|------------|---|-----------|
| | | | MBSPP | MJ |
| 2MBSPPP-4MJ90 | G62310-0204 | 7253-61305 | 1/8-28 | 7/16-20 |
| 4MBSPPP-4MJ90 | G62310-0404 | 7253-61315 | 1/4-19 | 7/16-20 |
| 4MBSPPP-5MJ90 | G62310-0405 | 7253-61325 | 1/4-19 | 1/2-20 |
| 4MBSPP-6MJ90 | G62310-0406 | 7253-61335 | 1/4-19 | 9/16-18 |
| 4MBSPP-8MJ90 | G62310-0408 | 7253-61345 | 1/4-19 | 3/4-16 |
| 6MBSPP-4MJ90 | G62310-0604 | 7253-61355 | 3/8-19 | 7/16-20 |
| 6MBSPP-5MJ90 | G62310-0605 | 7253-61365 | 3/8-19 | 1/2-20 |
| 6MBSPP-8MJ90 | G62310-0608 | 7253-61385 | 3/8-19 | 3/4-16 |
| 8MBSPP-6MJ90 | G62310-0806 | 7253-61395 | 1/2-14 | 9/16-18 |
| 8MBSPP-10MJ90 | G62310-0810 | 7253-61415 | 1/2-14 | 7/8-14 |
| 8MBSPP-12MJ90 | G62310-0812 | 7253-61425 | 1/2-14 | 1-1/16-12 |
| 12MBSPP-8MJ90 | G62310-1208 | 7253-61435 | 3/4-14 | 3/4-16 |
| 12MBSPP-10MJ90 | G62310-1210 | 7253-61445 | 3/4-14 | 7/8-14 |
| 12MBSPP-16MJ90 | G62310-1216 | 7253-61465 | 3/4-14 | 1-5/16-12 |
| 16MBSPP-12MJ90 | G62310-1612 | 7253-61475 | 1-11 | 1-1/16-12 |
| 16MBSPP-16MJ90 | G62310-1616 | 7253-61485 | 1-11 | 1-5/16-12 |
| 16MBSPP-20MJ90 | G62310-1620 | 7253-61495 | 1-11 | 1-5/8-12 |
| 20MBSPP-16MJ90 | G62310-2016 | 7253-61505 | 1-1/4-11 | 1-5/16-12 |
| 20MBSPP-20MJ90 | G62310-2020 | 7253-61515 | 1-1/4-11 | 1-5/8-12 |
| 24MBSPP-24MJ90 | G62310-2424 | 7253-61525 | 1-1/2-11 | 1-7/8-12 |

EQUIPMENT

HOSE/CPLG. SELECTION

TECH. DATA

EXT. & VERY HIGH PRESS. HOSE

GS CPLGS.

PCM CPLGS.

PCS CPLGS.

HIGH & MED. PRESS. HOSE

MEGACRIMP® CPLGS.

PC CPLGS.

FIELD ATTACHABLE CPLGS.

AIR BRAKE HOSE & CPLGS.

MEGATECH® C5 HOSE & CPLGS.

LOW PRESS. HOSE & CPLGS.

C14 HOSE & CPLGS.

POLARSEAL® HOSE & CPLGS.

PWR. STG. HOSE & CPLGS.

THERMO-PLASTIC HOSE & CPLGS.

ADAPTERS

QUICK DISCONNECT CPLGS.

ACCESSORIES & ASSORTMENTS

PART NUMBER INDEXES



Adapters — British to SAE — G62 Series

Male British Standard Pipe Parallel to Female JIC 37° Flare Swivel

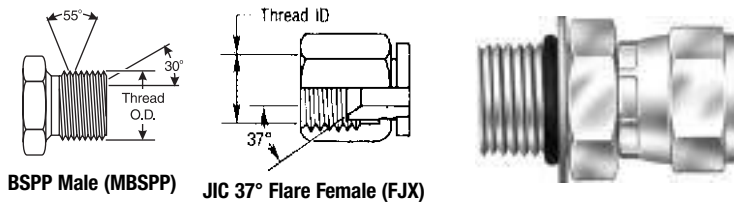

| DESCR | # | | |  | |
|---------------|-------------|-------------|------------|---|-----------|
| | | | | MBSPP | FJX |
| 2MBSPP-4FJX | G62320-0204 | G62320-0204 | 7253-61535 | 1/8-28 | 7/16-20 |
| 4MBSPP-4FJX | 87911 | G62320-0404 | 7253-15125 | 1/4-19 | 7/16-20 |
| 4MBSPP-5FJX | G62320-0405 | G62320-0405 | 7253-61545 | 1/4-19 | 1/2-20 |
| 4MBSPP-6FJX | G62320-0406 | G62320-0406 | 7253-61555 | 1/4-19 | 9/16-18 |
| 6MBSPP-4FJX | G62320-0604 | G62320-0604 | 7253-61565 | 3/8-19 | 7/16-20 |
| 6MBSPP-6FJX | 87912 | G62320-0606 | 7253-15135 | 3/8-19 | 9/16-18 |
| 6MBSPP-8FJX | G62320-0608 | G62320-0608 | 7253-61575 | 3/8-19 | 3/4-16 |
| 8MBSPP-4FJX | G62320-0804 | G62320-0804 | 7253-61585 | 1/2-14 | 7/16-20 |
| 8MBSPP-6FJX | G62320-0806 | G62320-0806 | 7253-61595 | 1/2-14 | 9/16-18 |
| 8MBSPP-8FJX | 87913 | G62320-0808 | 7253-15145 | 1/2-14 | 3/4-16 |
| 8MBSPP-10FJX | G62320-0810 | G62320-0810 | 7253-61605 | 1/2-14 | 7/8-14 |
| 8MBSPP-12FJX | G62320-0812 | G62320-0812 | 7253-61615 | 1/2-14 | 1-1/16-12 |
| 10MBSPP-8FJX | G62320-1008 | G62320-1008 | 7253-61625 | 5/8-14 | 3/4-16 |
| 10MBSPP-10FJX | 87914 | G62320-1010 | 7253-15155 | 5/8-14 | 7/8-14 |
| 12MBSPP-8FJX | G62320-1208 | G62320-1208 | 7253-61635 | 3/4-14 | 3/4-16 |
| 12MBSPP-12FJX | 87915 | G62320-1212 | 7253-15165 | 3/4-14 | 1-1/16-12 |
| 12MBSPP-16FJX | G62320-1216 | G62320-1216 | 7253-61645 | 3/4-14 | 1-5/16-12 |
| 16MBSPP-16FJX | 87916 | G62320-1616 | 7253-15175 | 1-11 | 1-5/16-12 |
| 16MBSPP-20FJX | G62320-1620 | G62320-1620 | 7253-61655 | 1-11 | 1-5/8-12 |
| 20MBSPP-16FJX | G62320-2016 | G62320-2016 | 7253-61665 | 1-1/4-11 | 1-5/16-12 |
| 20MBSPP-20FJX | G62320-2020 | G62320-2020 | 7253-61675 | 1-1/4-11 | 1-5/8-12 |
| 24MBSPP-24FJX | G62320-2424 | G62320-2424 | 7253-61685 | 1-1/2-11 | 1-7/8-12 |
| 32MBSPP-32FJX | G62320-3232 | G62320-3232 | 7253-61695 | 2-11 | 2-1/2-12 |

EQUIPMENT
HOSE/CPLG. SELECTION
TECH. DATA
EXT. & VERY HIGH PRESS. HOSE
GS CPLGS.
PCM CPLGS.
PCS CPLGS.
HIGH & MED. PRESS. HOSE
MEGACRIMP® CPLGS.
PC CPLGS.
FIELD ATTACHABLE CPLGS.
AIR BRAKE HOSE & CPLGS.
MEGATECH™ C5 HOSE & CPLGS.
LOW PRESS. HOSE & CPLGS.
C14 HOSE & CPLGS.
POLARSEAL® HOSE & CPLGS.
PWR. STG. HOSE & CPLGS.
THERMO-PLASTIC HOSE & CPLGS.
ADAPTERS
QUICK DISCONNECT CPLGS.
ACCESSORIES & ASSORTMENTS
PART NUMBER INDEXES



Male British Standard Pipe Parallel with O-Ring to Male JIC 37° Flare

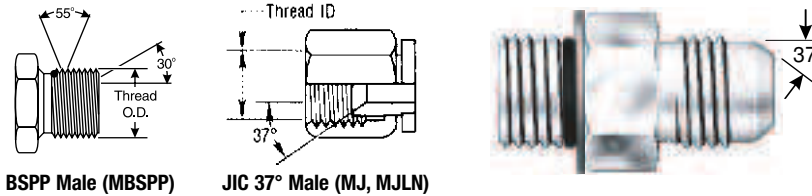

BSPP Male (MBSPP)

JIC 37° Male (MJ, MJLN)

| Descr | # | | |  | |
|----------------|-------------|-------------|------------|---|-----------|
| | | | | MBSPP | MJ |
| 2MBSPPOR-4MJ | 88045 | G62450-0204 | 7253-14005 | 1/8-28 | 7/16-20 |
| 4MBSPPOR-4MJ | 88046 | G62450-0404 | 7253-14015 | 1/4-19 | 7/16-20 |
| 4MBSPPOR-5MJ | G62450-0405 | G62450-0405 | 7253-61705 | 1/4-19 | 1/2-20 |
| 4MBSPPOR-6MJ | 88047 | G62450-0406 | 7253-14025 | 1/4-19 | 9/16-18 |
| 6MBSPPOR-4MJ | 88048 | G62450-0604 | 7253-14035 | 3/8-19 | 7/16-20 |
| 6MBSPPOR-5MJ | G62450-0605 | G62450-0605 | 7253-61715 | 3/8-19 | 1/2-20 |
| 6MBSPPOR-6MJ | 88049 | G62450-0606 | 7253-14045 | 3/8-19 | 9/16-18 |
| 6MBSPPOR-8MJ | 88050 | G62450-0608 | 7253-14055 | 3/8-19 | 3/4-16 |
| 8MBSPPOR-6MJ | 88051 | G62450-0806 | 7253-14075 | 1/2-14 | 9/16-18 |
| 8MBSPPOR-8MJ | 88052 | G62450-0808 | 7253-14085 | 1/2-14 | 3/4-16 |
| 8MBSPPOR-10MJ | G62450-0810 | G62450-0810 | 7253-61725 | 1/2-14 | 7/8-14 |
| 8MBSPPOR-12MJ | 88056 | G62450-0812 | 7253-14605 | 1/2-14 | 1-1/16-12 |
| 12MBSPPOR-8MJ | G62450-1208 | G62450-1208 | 7253-61735 | 3/4-14 | 3/4-16 |
| 12MBSPPOR-10MJ | G62450-1210 | G62450-1210 | 7253-61745 | 3/4-14 | 7/8-14 |
| 12MBSPPOR-12MJ | 88053 | G62450-1212 | 7253-14095 | 3/4-14 | 1-1/16-12 |
| 12MBSPPOR-16MJ | G62450-1216 | G62450-1216 | 7253-61755 | 3/4-14 | 1-5/16-12 |
| 16MBSPPOR-12MJ | G62450-1612 | G62450-1612 | 7253-61765 | 1-11 | 1-1/16-12 |
| 16MBSPPOR-16MJ | 88054 | G62450-1616 | 7253-14105 | 1-11 | 1-5/16-12 |
| 20MBSPPOR-20MJ | 88055 | G62450-2020 | 7253-14115 | 1-1/4-11 | 1-5/8-12 |
| 20MBSPPOR-24MJ | G62450-2024 | G62450-2024 | 7253-61775 | 1-1/4-11 | 1-7/8-12 |
| 24MBSPPOR-24MJ | G62450-2424 | G62450-2424 | 7253-61785 | 1-1/2-11 | 1-7/8-12 |

Male British Standard Pipe Parallel with O-Ring to Male JIC 37° Flare – 90°

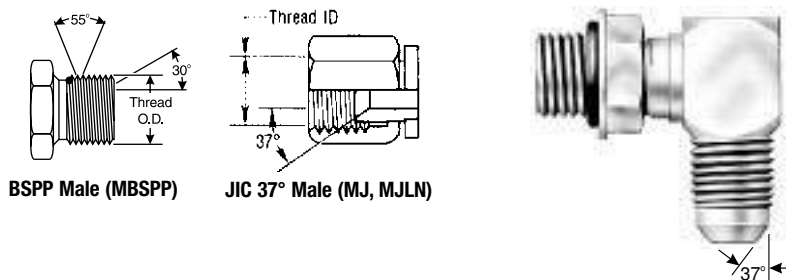

BSPP Male (MBSPP)

JIC 37° Male (MJ, MJLN)

| Descr | # | | |  | |
|------------------|-------|-------------|------------|---|-----------|
| | | | | MBSPP | MJ |
| 6MBSPPOR-6MJ90 | 87890 | G62460-0606 | 7253-14505 | 3/8-19 | 9/16-18 |
| 8MBSPPOR-8MJ90 | 87891 | G62460-0808 | 7253-14515 | 1/2-14 | 3/4-16 |
| 12MBSPPOR-12MJ90 | 87892 | G62460-1212 | 7253-14525 | 3/4-14 | 1-1/16-12 |

EQUIPMENT
HOSE/CPLG. SELECTION
TECH. DATA
EXT. & VERY HIGH PRESS. HOSE
GS CPLGS.
PCM CPLGS.
PCS CPLGS.
HIGH & MED. PRESS. HOSE
MEGACRIMP® CPLGS.
PC CPLGS.
FIELD ATTACHABLE CPLGS.
AIR BRAKE HOSE & CPLGS.
MEGATECH® C5 HOSE & CPLGS.
LOW PRESS. HOSE & CPLGS.
C14 HOSE & CPLGS.
POLARSEAL® HOSE & CPLGS.
PWR. STG. HOSE & CPLGS.
THERMO-PLASTIC HOSE & CPLGS.
ADAPTERS
QUICK DISCONNECT CPLGS.
ACCESSORIES & ASSORTMENTS
PART NUMBER INDEXES



Adapters — British to SAE — G62 Series

Male British Standard Pipe Parallel with O-Ring to Male Flat-Face O-Ring

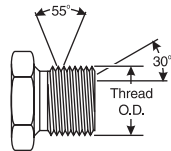

BSPP Male (MBSPP)

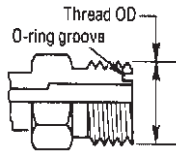

Male Flat-Face O-Ring (MFFOR)



| Descr | # | |  | |
|-------------------|-------------|------------|---|------------|
| | | | BSPP | FFOR |
| 2MBSPPOR-4MFFOR | G62470-0204 | 7253-61795 | 1/8-28 | 9/16-18 |
| 4MBSPPOR-4MFFOR | G62470-0404 | 7253-61805 | 1/4-19 | 9/16-18 |
| 4MBSPPOR-6MFFOR | G62470-0406 | 7253-61815 | 1/4-19 | 11/16-16 |
| 6MBSPPOR-6MFFOR | G62470-0606 | 7253-61825 | 3/8-19 | 11/16-16 |
| 6MBSPPOR-8MFFOR | G62470-0608 | 7253-61835 | 3/8-19 | 13/16-16 |
| 8MBSPPOR-6MFFOR | G62470-0806 | 7253-61845 | 1/2-14 | 11/16-16 |
| 8MBSPPOR-8MFFOR | G62470-0808 | 7253-61855 | 1/2-14 | 13/16-16 |
| 8MBSPPOR-10MFFOR | G62470-0810 | 7253-61865 | 1/2-14 | 1-14 |
| 12MBSPPOR-12MFFOR | G62470-1212 | 7253-61875 | 3/4-14 | 1-3/16-12 |
| 12MBSPPOR-16MFFOR | G62470-1216 | 7253-61885 | 3/4-14 | 1-7/16-12 |
| 16MBSPPOR-12MFFOR | G62470-1612 | 7253-61895 | 1-11 | 1-3/16-12 |
| 16MBSPPOR-16MFFOR | G62470-1616 | 7253-61905 | 1-11 | 1-7/16-12 |
| 20MBSPPOR-20MFFOR | G62470-2020 | 7253-61915 | 1-1/4-11 | 1-11/16-12 |
| 24MBSPPOR-24MFFOR | G62470-2424 | 7253-61925 | 1-1/2-11 | 2-12 |

Male British Standard Pipe Parallel with O-Ring to Male Flat-Face O-Ring — Long

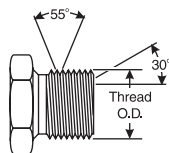

BSPP Male (MBSPP)

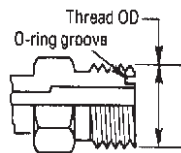

Male Flat-Face O-Ring (MFFOR)



| Descr | # | |  | |
|--------------------|-------------|------------|---|------------|
| | | | BSPP | FFOR |
| 6MBSPPOR-8MFFORL | G62471-0608 | 7253-61935 | 3/8-19 | 13/16-16 |
| 8MBSPPOR-8MFFORL | G62471-0808 | 7253-61945 | 1/2-14 | 13/16-16 |
| 8MBSPPOR-10MFFORL | G62471-0810 | 7253-61955 | 1/2-14 | 1-14 |
| 12MBSPPOR-10MFFORL | G62471-1210 | 7253-61965 | 3/4-14 | 1-14 |
| 12MBSPPOR-12MFFORL | G62471-1212 | 7253-61975 | 3/4-14 | 1-3/16-12 |
| 16MBSPPOR-16MFFORL | G62471-1616 | 7253-61985 | 1-11 | 1-7/16-12 |
| 20MBSPPOR-20MFFORL | G62471-2020 | 7253-61995 | 1-1/4-11 | 1-11/16-12 |



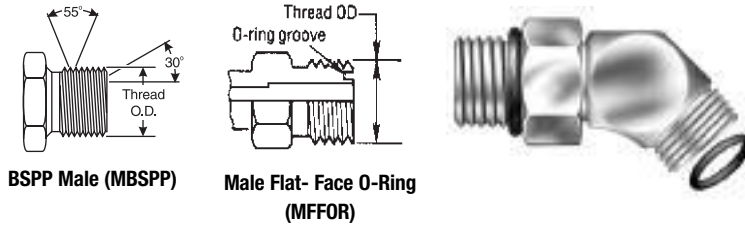

Male British Standard Pipe Parallel with O-Ring to Male Flat-Face O-Ring – 45°

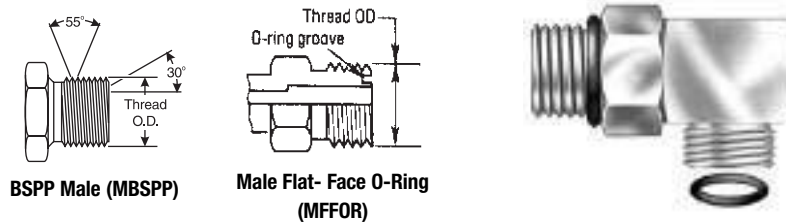

| Descr | # | |  | |
|--------------------|-------------|------------|---|----------|
| | | | MBSPP | MFFOR |
| 2MBSPPOR-4MFFOR45 | G62473-0204 | 7253-62005 | 1/8–28 | 9/16–18 |
| 4MBSPPOR-4MFFOR45 | G62473-0404 | 7253-62015 | 1/4–19 | 9/16–18 |
| 4MBSPPOR-6MFFOR45 | G62473-0406 | 7253-62025 | 1/4–19 | 11/16–16 |
| 6MBSPPOR-6MFFOR45 | G62473-0606 | 7253-62035 | 3/8–19 | 11/16–16 |
| 6MBSPPOR-8MFFOR45 | G62473-0608 | 7253-62045 | 3/8–19 | 13/16–16 |
| 8MBSPPOR-8MFFOR45 | G62473-0808 | 7253-62055 | 1/2–14 | 13/16–16 |
| 8MBSPPOR-10MFFOR45 | G62473-0810 | 7253-62065 | 1/2–14 | 1–14 |

Male British Standard Pipe Parallel with O-Ring to Male Flat-Face O-Ring – 90°



| Descr | # | |  | |
|---------------------|-------------|------------|---|------------|
| | | | MBSPP | MFFOR |
| 2MBSPPOR-4MFFOR90 | G62475-0204 | 7253-62075 | 1/8–28 | 9/16–18 |
| 4MBSPPOR-4MFFOR90 | G62475-0404 | 7253-62085 | 1/4–19 | 9/16–18 |
| 4MBSPPOR-6MFFOR90 | G62475-0406 | 7253-62095 | 1/4–19 | 11/16–16 |
| 4MBSPPOR-8MFFOR90 | G62475-0408 | 7253-62105 | 1/4–19 | 13/16–16 |
| 6MBSPPOR-6MFFOR90 | G62475-0606 | 7253-62115 | 3/8–19 | 11/16–16 |
| 6MBSPPOR-8MFFOR90 | G62475-0608 | 7253-62125 | 3/8–19 | 13/16–16 |
| 8MBSPPOR-6MFFOR90 | G62475-0806 | 7253-62135 | 1/2–14 | 11/16–16 |
| 8MBSPPOR-8MFFOR90 | G62475-0808 | 7253-62145 | 1/2–14 | 13/16–16 |
| 8MBSPPOR-10MFFOR90 | G62475-0810 | 7253-62155 | 1/2–14 | 1–14 |
| 8MBSPPOR-12MFFOR90 | G62475-0812 | 7253-62165 | 1/2–14 | 1-3/16–12 |
| 12MBSPPOR-12MFFOR90 | G62475-1212 | 7253-62175 | 3/4–14 | 1-3/16–12 |
| 12MBSPPOR-16MFFOR90 | G62475-1216 | 7253-62185 | 3/4–14 | 1-7/16–12 |
| 16MBSPPOR-12MFFOR90 | G62475-1612 | 7253-62195 | 1–11 | 1-3/16–12 |
| 16MBSPPOR-16MFFOR90 | G62475-1616 | 7253-62205 | 1–11 | 1-7/16–12 |
| 20MBSPPOR-16MFFOR90 | G62475-2016 | 7253-62215 | 1-1/4–11 | 1-7/16–12 |
| 20MBSPPOR-20MFFOR90 | G62475-2020 | 7253-62225 | 1-1/4–11 | 1-11/16–12 |
| 24MBSPPOR-24MFFOR90 | G62475-2424 | 7253-62235 | 1-1/2–11 | 2–12 |

EQUIPMENT

HOSE/CPLG.
SELECTION

TECH. DATA

EXT. &
VERY HIGH
PRESS. HOSE

GS CPLGS.

PCM CPLGS.

PCS CPLGS.

HIGH & MED.
PRESS. HOSEMEGACRIMP®
CPLGS.

PC CPLGS.

FIELD
ATTACHABLE
CPLGS.AIR BRAKE
HOSE &
CPLGS.MEGATECH®
C5
HOSE &
CPLGS.LOW PRESS.
HOSE &
CPLGS.C14 HOSE
& CPLGS.POLARSEAL®
HOSE &
CPLGS.PWR. STG.
HOSE &
CPLGS.THERMO-
PLASTIC
HOSE &
CPLGS.

ADAPTERS

QUICK
DISCONNECT
CPLGS.ACCESSORIES
& ASSORT-
MENTSPART NUMBER
INDEXES

Adapters — British to SAE — G62 Series

Female British Standard Pipe Parallel to Male Pipe NPTF

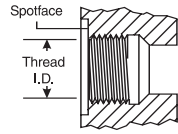

FBSPP Female

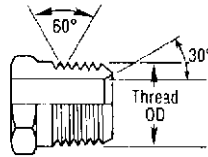

NPTF Solid Male (MP)



| Descr | # | |  | |
|--------------|-------------|------------|---|--------------|
| | | | FBSPP | MP (NPTF) |
| 2FBSPP-2MP | G62500-0202 | 7253-62245 | 1/8-28 | 1/8-27 |
| 2FBSPP-4MP | G62500-0204 | 7253-62255 | 1/8-28 | 1/4-18 |
| 4FBSPP-4MP | G62500-0404 | 7253-62265 | 1/4-19 | 1/4-18 |
| 4FBSPP-6MP | G62500-0406 | 7253-62275 | 1/4-19 | 3/8-18 |
| 4FBSPP-8MP | G62500-0408 | 7253-62285 | 1/4-19 | 1/2-14 |
| 6FBSPP-6MP | G62500-0606 | 7253-62295 | 3/8-19 | 3/8-18 |
| 6FBSPP-8MP | G62500-0608 | 7253-62305 | 3/8-19 | 1/2-14 |
| 8FBSPP-8MP | G62500-0808 | 7253-62315 | 1/2-14 | 1/2-14 |
| 8FBSPP-12MP | G62500-0812 | 7253-62325 | 1/2-14 | 3/4-14 |
| 12FBSPP-12MP | G62500-1212 | 7253-62335 | 3/4-14 | 3/4-14 |
| 12FBSPP-16MP | G62500-1216 | 7253-62345 | 3/4-14 | 1-11 1/2 |
| 16FBSPP-16MP | G62500-1616 | 7253-62355 | 1-11 | 1-11 1/2 |
| 20FBSPP-20MP | G62500-2020 | 7253-62365 | 1-1/4-11 | 1-1/4-11-1/2 |
| 20FBSPP-24MP | G62500-2024 | 7253-62375 | 1-1/4-11 | 1-1/4-11-1/2 |
| 24FBSPP-24MP | G62500-2424 | 7253-62385 | 1-1/2-11 | 1-1/2-11-1/2 |
| 32FBSPP-32MP | G62500-3232 | 7253-62395 | 2-11 | 2-11-1/2 |

Female British Standard Pipe Parallel to Female Pipe NPTF

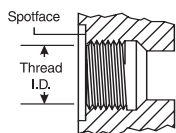

FBSPP Female

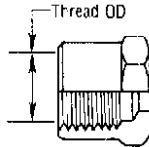

NPTF or NPSF Solid Female (FP)

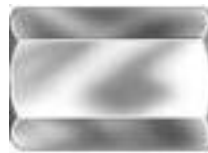

| Descr | # | |  | |
|--------------|-------------|------------|---|--------------|
| | | | FBSPP | FP (NPTF) |
| 4FBSPP-4FP | G62520-0404 | 7253-65525 | 1/4-19 | 1/4-18 |
| 6FBSPP-6FP | G62520-0606 | 7253-65535 | 3/8-19 | 3/8-18 |
| 8FBSPP-8FP | G62520-0808 | 7253-65545 | 1/2-14 | 1/2-14 |
| 12FBSPP-12FP | G62520-1212 | 7253-65555 | 3/4-14 | 3/4-14 |
| 16FBSPP-16FP | G62520-1616 | 7253-65565 | 1-11 | 1-11-1/2 |
| 20FBSPP-20FP | G62520-2020 | 7253-65575 | 1-1/4-11 | 1-1/4-11-1/2 |



Female British Standard Pipe Parallel to Male JIC 37° Flare

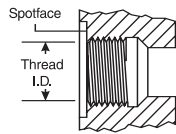

FBSPP Female

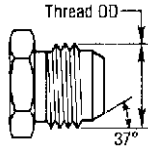

JIC 37° Male (MJ, MJLN)



| Descr | # | | |  | |
|--------------|-------------|-------------|------------|---|-----------|
| | | | | FBSPP | MJ |
| 2FBSPP-4MJ | 88360 | G62550-0204 | 7253-14155 | 1/8-28 | 7/16-20 |
| 4FBSPP-4MJ | 88359 | G62550-0404 | 7253-14225 | 1/4-19 | 7/16-20 |
| 4FBSPP-6MJ | 88361 | G62550-0406 | 7253-14165 | 1/4-19 | 9/16-18 |
| 6FBSPP-6MJ | 88362 | G62550-0606 | 7253-14175 | 3/8-19 | 9/16-18 |
| 6FBSPP-8MJ | G62550-0608 | G62550-0608 | 7253-62405 | 3/8-19 | 3/4-16 |
| 8FBSPP-8MJ | 88363 | G62550-0808 | 7253-14185 | 1/2-14 | 3/4-16 |
| 12FBSPP-12MJ | 88364 | G62550-1212 | 7253-14195 | 3/4-14 | 1-1/16-12 |
| 16FBSPP-16MJ | 88365 | G62550-1616 | 7253-14205 | 1-11 | 1-5/16-12 |
| 20FBSPP-20MJ | 88366 | G62550-2020 | 7253-14215 | 1-1/4-11 | 1-5/8-12 |
| 24FBSPP-24MJ | G62550-2424 | G62550-2424 | 7253-62415 | 1-1/2-11 | 1-7/8-12 |

Female British Standard Pipe Parallel Swivel to Male Pipe NPTF - 90°

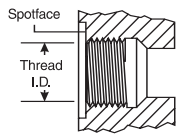

FBSPP Female

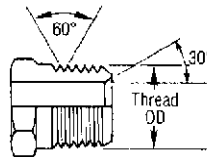

NPTF Solid Male (MP)



| Descr | # | | |  | |
|-----------------|-------------|--|------------|---|--------------|
| | | | | FBSPP | MP (NPTF) |
| 2FBSPPX-2MP90 | G62605-0202 | | 7253-62425 | 1/8-28 | 1/8-27 |
| 4FBSPPX-4MP90 | G62605-0404 | | 7253-62435 | 1/4-19 | 1/4-18 |
| 6FBSPPX-6MP90 | G62605-0606 | | 7253-62445 | 3/8-19 | 3/8-18 |
| 8FBSPPX-8MP90 | G62605-0808 | | 7253-62455 | 1/2-14 | 1/2-14 |
| 12FBSPPX-12MP90 | G62605-1212 | | 7253-62465 | 3/4-14 | 3/4-14 |
| 16FBSPPX-16MP90 | G62605-1616 | | 7253-62475 | 1-11 | 1-11-1/2 |
| 20FBSPPX-20MP90 | G62605-2020 | | 7253-62485 | 1-1/4-11 | 1-1/4-11-1/2 |
| 24FBSPPX-24MP90 | G62605-2424 | | 7253-62495 | 1-1/2-11 | 1-1/4-11-1/2 |

EQUIPMENT
HOSE/CPLG. SELECTION
TECH. DATA
EXT. & VERY HIGH PRESS. HOSE
GS CPLGS.
PCM CPLGS.
PCS CPLGS.
HIGH & MED. PRESS. HOSE
MEGACRIMP® CPLGS.
PC CPLGS.
FIELD ATTACHABLE CPLGS.
AIR BRAKE HOSE & CPLGS.
MEGATECH® C5 HOSE & CPLGS.
LOW PRESS. HOSE & CPLGS.
C14 HOSE & CPLGS.
POLARSEAL® HOSE & CPLGS.
PWR. STG. HOSE & CPLGS.
THERMO-PLASTIC HOSE & CPLGS.
ADAPTERS
QUICK DISCONNECT CPLGS.
ACCESSORIES & ASSORTMENTS
PART NUMBER INDEXES

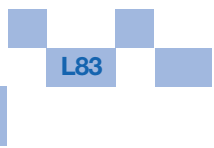

Adapters — British to SAE — G62 Series

Female British Standard Pipe Parallel Swivel to Male JIC 37° Flare

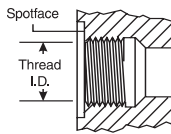

FBSPP Female

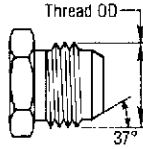

JIC 37° Male (MJ, MJLN)



| DESCR | # | | |  | |
|---------------|-------------|-------------|------------|---|-----------|
| | | | | FBSPP | MJ |
| 2FBSPPX-4MJ | G62650-0204 | G62650-0204 | 7253-62545 | 1/8-28 | 7/16-20 |
| 4FBSPPX-4MJ | 87923 | G62650-0404 | 7253-15245 | 1/4-19 | 7/16-20 |
| 4FBSPPX-5MJ | G62650-0405 | G62650-0405 | 7253-62555 | 1/4-19 | 1/2-20 |
| 4FBSPPX-6MJ | G62650-0406 | G62650-0406 | 7253-62565 | 1/4-19 | 9/16-18 |
| 6FBSPPX-4MJ | G62650-0604 | G62650-0604 | 7253-62575 | 3/8-19 | 7/16-20 |
| 6FBSPPX-5MJ | G62650-0605 | G62650-0605 | 7253-62585 | 3/8-19 | 1/2-20 |
| 6FBSPPX-6MJ | 87924 | G62650-0606 | 7253-15255 | 3/8-19 | 9/16-18 |
| 6FBSPPX-8MJ | G62650-0608 | G62650-0608 | 7253-62595 | 3/8-19 | 3/4-16 |
| 6FBSPPX-10MJ | G62650-0610 | G62650-0610 | 7253-62605 | 3/8-19 | 7/8-14 |
| 8FBSPPX-6MJ | G62650-0806 | G62650-0806 | 7253-62615 | 1/2-14 | 9/16-18 |
| 8FBSPPX-8MJ | 87925 | G62650-0808 | 7253-15265 | 1/2-14 | 3/4-16 |
| 8FBSPPX-10MJ | G62650-0810 | G62650-0810 | 7253-62625 | 1/2-14 | 7/8-14 |
| 10FBSPPX-8MJ | G62650-1008 | G62650-1008 | 7253-62635 | 5/8-14 | 3/4-16 |
| 10FBSPPX-10MJ | 87926 | G62650-1010 | 7253-15275 | 5/8-14 | 7/8-14 |
| 12FBSPPX-8MJ | G62650-1208 | G62650-1208 | 7253-62645 | 3/4-14 | 3/4-16 |
| 12FBSPPX-10MJ | G62650-1210 | G62650-1210 | 7253-62655 | 3/4-14 | 7/8-14 |
| 12FBSPPX-12MJ | 87927 | G62650-1212 | 7253-15285 | 3/4-14 | 1-1/16-12 |
| 16FBSPPX-12MJ | G62650-1612 | G62650-1612 | 7253-62675 | 1-11 | 1 1/16-12 |
| 16FBSPPX-16MJ | 87928 | G62650-1616 | 7253-15295 | 1-11 | 1-5/16-12 |
| 20FBSPPX-20MJ | G62650-2020 | G62650-2020 | 7253-62685 | 1-1/4-11 | 1-5/8-12 |
| 24FBSPPX-24MJ | G62650-2424 | G62650-2424 | 7253-62695 | 1-1/2-11 | 1-7/8-12 |

EQUIPMENT
HOSE/CPLG. SELECTION
TECH. DATA
EXT. & VERY HIGH PRESS. HOSE
GS CPLGS.
PCM CPLGS.
PCS CPLGS.
HIGH & MED. PRESS. HOSE
MEGACRIMP® CPLGS.
PC CPLGS.
FIELD ATTACHABLE CPLGS.
AIR BRAKE HOSE & CPLGS.
MEGATECH™ C5 HOSE & CPLGS.
LOW PRESS. HOSE & CPLGS.
C14 HOSE & CPLGS.
POLARSEAL® HOSE & CPLGS.
PWR. STG. HOSE & CPLGS.
THERMO-PLASTIC HOSE & CPLGS.
ADAPTERS
QUICK DISCONNECT CPLGS.
ACCESSORIES & ASSORTMENTS
PART NUMBER INDEXES



Female British Standard Pipe Parallel Swivel to Female JIC 37° Flare Swivel

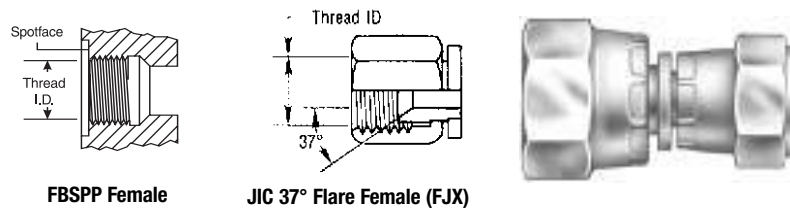

FBSPP Female

JIC 37° Flare Female (FJX)

| Descr | # | | |  | |
|----------------|-------------|-------------|------------|---|-----------|
| | | | | FBSPP | FJX |
| 4FBSPPX-4FJX | 87929 | G62660-0404 | 7253-15305 | 1/4-19 | 7/16-20 |
| 4FBSPPX-6FJX | G62660-0406 | G62660-0406 | 7253-62505 | 1/4-19 | 9/16-18 |
| 6FBSPPX-6FJX | 87930 | G62660-0606 | 7253-15315 | 3/8-19 | 9/16-18 |
| 6FBSPPX-8FJX | G62660-0608 | G62660-0608 | 7253-62515 | 3/8-19 | 3/4-16 |
| 8FBSPPX-6FJX | G62660-0806 | G62660-0806 | 7253-62525 | 1/2-14 | 9/16-18 |
| 8FBSPPX-8FJX | 87931 | G62660-0808 | 7253-15325 | 1/2-14 | 3/4-16 |
| 10FBSPPX-10FJX | 87932 | G62660-1010 | 7253-15335 | 5/8-14 | 7/8-14 |
| 12FBSPPX-12FJX | 87933 | G62660-1212 | 7253-15345 | 3/4-14 | 1-1/16-12 |
| 16FBSPPX-16FJX | 87934 | G62660-1616 | 7253-15355 | 1-11 | 1-5/16-12 |
| 20FBSPPX-20FJX | G62660-2020 | G62660-2020 | 7253-62535 | 1-1/4-11 | 1-5/8-12 |

Female British Flat-Face O-Ring to Male JIC 37° Flare

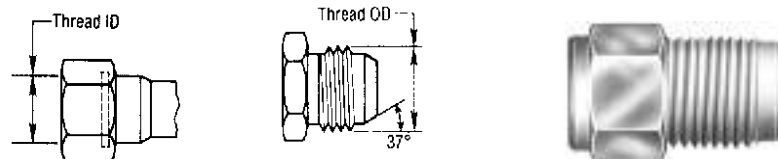

Female British Flat-Face (FBFF)

JIC 37° Male (MJ, MJLN)

| Descr | # | | |  | |
|---------------|-------------|------------|--------|---|----|
| | | | | FBFF | MJ |
| 6FBFFOR-6MJ | G62801-0606 | 7253-62705 | 3/8-19 | 9/16-18 | |
| 8FBFFOR-6MJ | G62801-0806 | 7253-62715 | 1/2-14 | 9/16-18 | |
| 8FBFFOR-8MJ | G62801-0808 | 7253-62725 | 1/2-14 | 3/4-16 | |
| 8FBFFOR-10MJ | G62801-0810 | 7253-62735 | 1/2-14 | 7/8-14 | |
| 10FBFFOR-8MJ | G62801-1008 | 7253-62745 | 5/8-14 | 3/4-16 | |
| 12FBFFOR-8MJ | G62801-1208 | 7253-62755 | 3/4-14 | 3/4-16 | |
| 12FBFFOR-10MJ | G62801-1210 | 7253-62765 | 3/4-14 | 7/8-14 | |
| 12FBFFOR-12MJ | G62801-1212 | 7253-62775 | 3/4-14 | 1-1/16-12 | |

EQUIPMENT

HOSE/CPLG. SELECTION

TECH. DATA

EXT. & VERY HIGH PRESS. HOSE

GS CPLGS.

PCM CPLGS.

PCS CPLGS.

HIGH & MED. PRESS. HOSE

MEGACRIMP® CPLGS.

PC CPLGS.

FIELD ATTACHABLE CPLGS.

AIR BRAKE HOSE & CPLGS.

MEGATECH® C5 HOSE & CPLGS.

LOW PRESS. HOSE & CPLGS.

C14 HOSE & CPLGS.

POLARSEAL® HOSE & CPLGS.

PWR. STG. HOSE & CPLGS.

THERMO-PLASTIC HOSE & CPLGS.

ADAPTERS

QUICK DISCONNECT CPLGS.

ACCESSORIES & ASSORTMENTS

PART NUMBER INDEXES



Metric Conversion

Male Metric O-Ring Plug



| Descr | # | |  |
|-------------|-------------|------------|---|
| 12MMOR-PLUG | G63099-0012 | 7253-65415 | M12X1.5 |
| 14MMOR-PLUG | G63099-0014 | 7253-65425 | M14X1.5 |
| 16MMOR-PLUG | G63099-0016 | 7253-65435 | M16X1.5 |
| 18MMOR-PLUG | G63099-0018 | 7253-65445 | M18X1.5 |
| 20MMOR-PLUG | G63099-0020 | 7253-65455 | M20X1.5 |
| 22MMOR-PLUG | G63099-0022 | 7253-65465 | M22X1.5 |
| 24MMOR-PLUG | G63099-0024 | 7253-65475 | M24X1.5 |
| 26MMOR-PLUG | G63099-0026 | 7253-65485 | M26X1.5 |
| 30MMOR-PLUG | G63099-0030 | 7253-65495 | M30X2.0 |
| 36MMOR-PLUG | G63099-0036 | 7253-65505 | M36X2.0 |
| 42MMOR-PLUG | G63099-0042 | 7253-65515 | M42X2.0 |

| |
|------------------------------|
| EQUIPMENT |
| HOSE/CPLG. SELECTION |
| TECH. DATA |
| EXT. & VERY HIGH PRESS. HOSE |
| GS CPLGS. |
| PCM CPLGS. |
| PCS CPLGS. |
| HIGH & MED. PRESS. HOSE |
| MEGACRIMP® CPLGS. |
| PC CPLGS. |
| FIELD ATTACHABLE CPLGS. |
| AIR BRAKE HOSE & CPLGS. |
| MEGATECH™ C5 HOSE & CPLGS. |
| LOW PRESS. HOSE & CPLGS. |
| C14 HOSE & CPLGS. |
| POLARSEAL® HOSE & CPLGS. |
| PWR. STG. HOSE & CPLGS. |
| THERMO-PLASTIC HOSE & CPLGS. |
| ADAPTERS |
| QUICK DISCONNECT CPLGS. |
| ACCESSORIES & ASSORTMENTS |
| PART NUMBER INDEXES |



Male Metric DIN 3852 Type A to Female Pipe NPTF

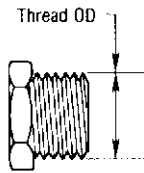

Male Metric

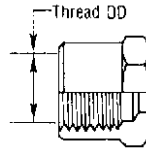

NPTF or NPSF Solid Female (FP)



| Descr | # | |  | |
|-----------|-------------|------------|---|-----------|
| | | | MM | FP (NPTF) |
| 10MM-2FP | G63120-1002 | 7253-62785 | M10X1.0 | 1/8-27 |
| 12MM-2FP | G63120-1202 | 7253-62795 | M12X1.5 | 1/8-27 |
| 12MM-4FP | G63120-1204 | 7253-62805 | M12X1.5 | 1/4-18 |
| 12MM-6FP | G63120-1206 | 7253-62815 | M12X1.5 | 3/8-18 |
| 14MM-4FP | G63120-1404 | 7253-62825 | M14X1.5 | 1/4-18 |
| 16MM-6FP | G63120-1606 | 7253-62835 | M16X1.5 | 3/8-18 |
| 16MM-8FP | G63120-1608 | 7253-62845 | M16X1.5 | 1/2-14 |
| 18MM-6FP | G63120-1806 | 7253-62855 | M18X1.5 | 3/8-18 |
| 18MM-8FP | G63120-1808 | 7253-62865 | M18X1.5 | 1/2-14 |
| 20MM-4FP | G63120-2004 | 7253-62875 | M20X1.5 | 1/4-18 |
| 20MM-6FP | G63120-2006 | 7253-62885 | M20X1.5 | 3/8-18 |
| 20MM-8FP | G63120-2008 | 7253-62895 | M20X1.5 | 1/2-14 |
| 22MM-6FP | G63120-2206 | 7253-62905 | M22X1.5 | 3/8-18 |
| 22MM-8FP | G63120-2208 | 7253-62915 | M22X1.5 | 1/2-14 |
| 22MM-12FP | G63120-2212 | 7253-62925 | M22X1.5 | 3/4-14 |
| 24MM-12FP | G63120-2412 | 7253-62935 | M24X1.5 | 3/4-14 |
| 26MM-12FP | G63120-2612 | 7253-62945 | M26X1.5 | 3/4-14 |
| 27MM-12FP | G63120-2712 | 7253-62955 | M27X2.0 | 3/4-14 |
| 33MM-16FP | G63120-3316 | 7253-62965 | M33X2.0 | 1-5/16-12 |

EQUIPMENT

HOSE/CPLG. SELECTION

TECH. DATA

EXT. & VERY HIGH PRESS. HOSE

GS CPLGS.

PCM CPLGS.

PCS CPLGS.

HIGH & MED. PRESS. HOSE

MEGACRIMP® CPLGS.

PC CPLGS.

FIELD ATTACHABLE CPLGS.

AIR BRAKE HOSE & CPLGS.

MEGATECH® C5 HOSE & CPLGS.

LOW PRESS. HOSE & CPLGS.

C14 HOSE & CPLGS.

POLARSEAL® HOSE & CPLGS.

PWR. STG. HOSE & CPLGS.

THERMO-PLASTIC HOSE & CPLGS.

ADAPTERS

QUICK DISCONNECT CPLGS.

ACCESSORIES & ASSORTMENTS

PART NUMBER INDEXES



Adapters — Metric Conversion — G63 Series

Male Metric DIN 3852 Type A to Male JIC 37° Flare

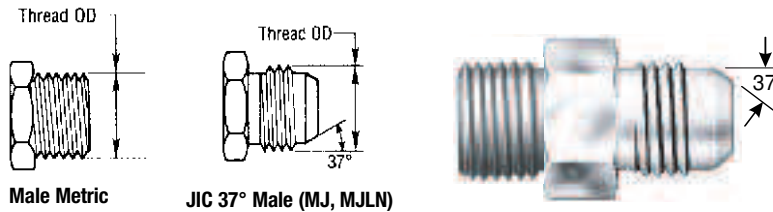

Male Metric

JIC 37° Male (MJ, MJLN)

| Descr | # | | |  | | |
|-------------------------------------|-----------|-------------|-------------|---|---------|-----------|
| | | | | MM | MJ | |
| 10MM-4MJ | 88030 | G63150-1004 | 7253-14355 | M10X1.0 | 7/16-20 | |
| 12MM-4MJ | 88031 | G63150-1204 | 7253-14365 | M12X1.5 | 7/16-20 | |
| MEGACRIMP® CPLGS. | 12MM-5MJ | G63150-1205 | 7253-62975 | M12X1.5 | 1/2-20 | |
| | 12MM-6MJ | G63150-1206 | 7253-62985 | M12X1.5 | 9/16-18 | |
| PC CPLGS. | 14MM-4MJ | G63150-1404 | 7253-62995 | M14X1.5 | 7/16-20 | |
| | 14MM-6MJ | 88032 | G63150-1406 | 7253-14375 | M14X1.5 | 9/16-18 |
| FIELD ATTACHABLE CPLGS. | 14MM-8MJ | G63150-1408 | 7253-63005 | M14X1.5 | 3/4-16 | |
| | 16MM-5MJ | G63150-1605 | 7253-63015 | M16X1.5 | 1/2-20 | |
| | 16MM-6MJ | 88033 | G63150-1606 | 7253-14385 | M16X1.5 | 9/16-18 |
| AIR BRAKE HOSE & CPLGS. | 16MM-8MJ | 88034 | G63150-1608 | 7253-14395 | M16X1.5 | 3/4-16 |
| | 18MM-8MJ | 88035 | G63150-1808 | 7253-14405 | M18X1.5 | 3/4-16 |
| | 18MM-10MJ | 88036 | G63150-1810 | 7253-14415 | M18X1.5 | 7/8-14 |
| MEGATECH™ C5 HOSE & CPLGS. | 20MM-10MJ | 88037 | G63150-2010 | 7253-14425 | M20X1.5 | 7/8-14 |
| | 22MM-8MJ | G63150-2208 | G63150-2208 | 7253-63025 | M22X1.5 | 3/4-16 |
| | 22MM-10MJ | 88038 | G63150-2210 | 7253-14435 | M22X1.5 | 7/8-14 |
| LOW PRESS. HOSE & CPLGS. | 22MM-12MJ | 88039 | G63150-2212 | 7253-14445 | M22X1.5 | 1-1/16-12 |
| | 26MM-12MJ | G63150-2612 | G63150-2612 | 7253-63035 | M26X1.5 | 1 1/16-12 |
| | 27MM-12MJ | 88040 | G63150-2712 | 7253-14455 | M27X2.0 | 1-1/16-12 |
| C14 HOSE & CPLGS. | 27MM-16MJ | G63150-2716 | G63150-2716 | 7253-63045 | M27X2.0 | 1-5/16-12 |
| | 33MM-16MJ | 88041 | G63150-3316 | 7253-14465 | M33X2.0 | 1-5/16-12 |
| | 33MM-20MJ | G63150-3320 | G63150-3320 | 7253-63055 | M33X1.5 | 1-5/8-12 |
| POLARSEAL® HOSE & CPLGS. | 42MM-20MJ | 88042 | G63150-4220 | 7253-14475 | M42X2.0 | 1-5/8-12 |
| | 48MM-24MJ | G63150-4824 | G63150-4824 | 7253-63065 | M48X1.5 | 1-7/8-12 |

EQUIPMENT
HOSE/CPLG. SELECTION
TECH. DATA
EXT. & VERY HIGH PRESS. HOSE
GS CPLGS.
PCM CPLGS.
PCS CPLGS.
HIGH & MED. PRESS. HOSE
MEGACRIMP® CPLGS.
PC CPLGS.
FIELD ATTACHABLE CPLGS.
AIR BRAKE HOSE & CPLGS.
MEGATECH™ C5 HOSE & CPLGS.
LOW PRESS. HOSE & CPLGS.
C14 HOSE & CPLGS.
POLARSEAL® HOSE & CPLGS.
PWR. STG. HOSE & CPLGS.
THERMO-PLASTIC HOSE & CPLGS.
ADAPTERS
QUICK DISCONNECT CPLGS.
ACCESSORIES & ASSORTMENTS
PART NUMBER INDEXES

Adapters — Metric Conversion — G63 Series

Male Metric DIN 3852 Type A to Male JIC 37° Flare – 90°

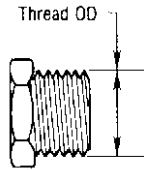

Male Metric

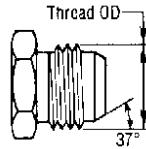

JIC 37° Male (MJ, MJLN)



| Descr | # | |  | |
|-------------|-------------|------------|---|-----------|
| | | | MM | MJ |
| 10MM-4MJ90 | G63160-1004 | 7253-65585 | M10X1.5 | 7/16-20 |
| 12MM-4MJ90 | G63160-1204 | 7253-65595 | M12X1.5 | 7/16-20 |
| 12MM-5MJ90 | G63160-1205 | 7253-65615 | M12X1.5 | 1/2-20 |
| 12MM-6MJ90 | G63160-1206 | 7253-65625 | M12X1.5 | 9/16-18 |
| 14MM-4MJ90 | G63160-1404 | 7253-65605 | M14X1.5 | 7/16-20 |
| 14MM-6MJ90 | G63160-1406 | 7253-65635 | M14X1.5 | 9/16-18 |
| 16MM-6MJ90 | G63160-1606 | 7253-65645 | M16X1.5 | 9/16-18 |
| 16MM-8MJ90 | G63160-1608 | 7253-65655 | M16X1.5 | 3/4-16 |
| 18MM-8MJ90 | G63160-1808 | 7253-65665 | M18X1.5 | 3/4-16 |
| 18MM-10MJ90 | G63160-1810 | 7253-65685 | M18X1.5 | 7/8-14 |
| 20MM-10MJ90 | G63160-2010 | 7253-65695 | M20X1.5 | 7/8-14 |
| 22MM-8MJ90 | G63160-2208 | 7253-65675 | M22X1.5 | 3/4-16 |
| 22MM-10MJ90 | G63160-2210 | 7253-65705 | M22X1.5 | 7/8-14 |
| 22MM-12MJ90 | G63160-2212 | 7253-65715 | M22X1.5 | 1-1/16-12 |
| 26MM-12MJ90 | G63160-2612 | 7253-65725 | M26X1.5 | 1-1/16-12 |
| 27MM-16MJ90 | G63160-2716 | 7253-65735 | M27X2.0 | 1-5/16-12 |
| 33MM-16MJ90 | G63160-3316 | 7253-65745 | M33X2.0 | 1-5/16-12 |
| 42MM-20MJ90 | G63160-4220 | 7253-65755 | M42X2.0 | 1-5/8-12 |

EQUIPMENT

HOSE/CPLG. SELECTION

TECH. DATA

EXT. & VERY HIGH PRESS. HOSE

GS CPLGS.

PCM CPLGS.

PCS CPLGS.

HIGH & MED. PRESS. HOSE

MEGACRIMP® CPLGS.

PC CPLGS.

FIELD ATTACHABLE CPLGS.

AIR BRAKE HOSE & CPLGS.

MEGATECH™ C5 HOSE & CPLGS.

LOW PRESS. HOSE & CPLGS.

C14 HOSE & CPLGS.

POLARSEAL® HOSE & CPLGS.

PWR. STG. HOSE & CPLGS.

THERMO-PLASTIC HOSE & CPLGS.

ADAPTERS

QUICK DISCONNECT CPLGS.

ACCESSORIES & ASSORTMENTS

PART NUMBER INDEXES



Adapters — Metric Conversion — G63 Series

Male DIN 24° Cone – Light Series to Male JIC 37° Flare

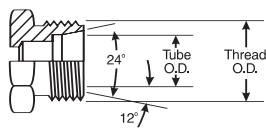

**Male 24° Cone, DIN
2353 (MDL/MDH)**

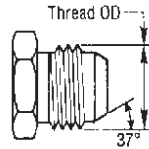

JIC 37° Male (MJ, MJLN)



| Descr | # | | |  | |
|------------|-------------|-------------|------------|---|-----------|
| | | | | MDL | MJ |
| 6MDL-4MJ | G63350-0604 | G63350-0604 | 7253-63075 | M12X1.5 | 7/16-20 |
| 8MDL-4MJ | 87935 | G63350-0804 | 7253-15365 | M14X1.5 | 7/16-20 |
| 8MDL-6MJ | G63350-0806 | G63350-0806 | 7253-63095 | M14X1.5 | 9/16-18 |
| 10MDL-4MJ | G63350-1004 | G63350-1004 | 7253-63105 | M16X1.5 | 7/16-20 |
| 10MDL-6MJ | 87936 | G63350-1006 | 7253-15375 | M16X1.5 | 9/16-18 |
| 10MDL-8MJ | G63350-1008 | G63350-1008 | 7253-63115 | M16X1.5 | 3/4-16 |
| 12MDL-6MJ | 87898 | G63350-1206 | 7253-15585 | M18X1.5 | 9/16-18 |
| 12MDL-8MJ | G63350-1208 | G63350-1208 | 7253-63135 | M18X1.5 | 3/4-16 |
| 15MDL-8MJ | 87937 | G63350-1508 | 7253-15385 | M22X1.5 | 3/4-16 |
| 15MDL-10MJ | G63350-1510 | G63350-1510 | 7253-63145 | M22X1.5 | 7/8-14 |
| 15MDL-12MJ | G63350-1512 | G63350-1512 | 7253-63155 | M22X1.5 | 1-1/16-12 |
| 18MDL-10MJ | 87938 | G63350-1810 | 7253-15515 | M26X1.5 | 7/8-14 |
| 18MDL-12MJ | G63350-1812 | G63350-1812 | 7253-63165 | M26X1.5 | 1-1/16-12 |
| 22MDL-12MJ | 87939 | G63350-2212 | 7253-15395 | M30X2.0 | 1-1/16-12 |
| 28MDL-16MJ | 87940 | G63350-2816 | 7253-15405 | M36X2.0 | 1-5/16-12 |
| 35MDL-20MJ | G63350-3520 | G63350-3520 | 7253-63175 | M45X2.0 | 1-5/8-12 |
| 42MDL-24MJ | G63350-4224 | G63350-4224 | 7253-63185 | M52X2.0 | 1-7/8-12 |

EQUIPMENT
HOSE/CPLG. SELECTION
TECH. DATA
EXT. & VERY HIGH PRESS. HOSE
GS CPLGS.
PCM CPLGS.
PCS CPLGS.
HIGH & MED. PRESS. HOSE
MEGACRIMP® CPLGS.
PC CPLGS.
FIELD ATTACHABLE CPLGS.
AIR BRAKE HOSE & CPLGS.
MEGATECH™ C5 HOSE & CPLGS.
LOW PRESS. HOSE & CPLGS.
C14 HOSE & CPLGS.
POLARSEAL® HOSE & CPLGS.
PWR. STG. HOSE & CPLGS.
THERMO-PLASTIC HOSE & CPLGS.
ADAPTERS
QUICK DISCONNECT CPLGS.
ACCESSORIES & ASSORTMENTS
PART NUMBER INDEXES

Adapters — Metric Conversion — G63 Series

Female DIN 24° Cone Swivel – Light Series to Male JIC 37° Flare

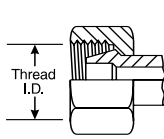

Female 24°

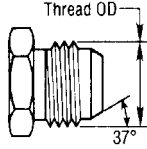

JIC 37° Male (MJ, MJLN)



| Descr | # | | |  | |
|-------------|-------------|-------------|------------|---|-----------|
| | | | | FDLX | MJ |
| 6FDLX-4MJ | G63450-0604 | G63450-0604 | 7253-64725 | M12X1.5 | 7/16–20 |
| 6FDLX-5MJ | G63450-0605 | G63450-0605 | 7253-64735 | M12X1.5 | 1/2–20 |
| 8FDLX-4MJ | 87947 | G63450-0804 | 7253-15465 | M14X1.5 | 7/16–20 |
| 8FDLX-6MJ | G63450-0806 | G63450-0806 | 7253-64755 | M14X1.5 | 9/16–18 |
| 10FDLX-6MJ | 87948 | G63450-1006 | 7253-15475 | M16X1.5 | 9/16–18 |
| 10FDLX-8MJ | G63450-1008 | G63450-1008 | 7253-64775 | M16X1.5 | 3/4–16 |
| 12FDLX-6MJ | 87899 | G63450-1206 | 7253-15545 | M18X1.5 | 9/16–18 |
| 12FDLX-8MJ | G63450-1208 | G63450-1208 | 7253-64795 | M18X1.5 | 3/4–16 |
| 12FDLX-10MJ | G63450-1210 | G63450-1210 | 7253-64805 | M18X1.5 | 7/8–14 |
| 15FDLX-6MJ | G63450-1506 | G63450-1506 | 7253-64815 | M22X1.5 | 9/16–18 |
| 15FDLX-8MJ | 87949 | G63450-1508 | 7253-15485 | M22X1.5 | 3/4–16 |
| 15FDLX-10MJ | G63450-1510 | G63450-1510 | 7253-64835 | M22X1.5 | 7/8–14 |
| 22FDLX-12MJ | 87950 | G63450-2212 | 7253-15495 | M30X2.0 | 1-1/16–12 |
| 28FDLX-16MJ | 87951 | G63450-2816 | 7253-15505 | M36X2.0 | 1-5/16–12 |

- EQUIPMENT
- HOSE/CPLG. SELECTION
- TECH. DATA
- EXT. & VERY HIGH PRESS. HOSE
- GS CPLGS.
- PCM CPLGS.
- PCS CPLGS.
- HIGH & MED. PRESS. HOSE
- MEGACRIMP® CPLGS.
- PC CPLGS.
- FIELD ATTACHABLE CPLGS.
- AIR BRAKE HOSE & CPLGS.
- MEGATECH™ C5 HOSE & CPLGS.
- LOW PRESS. HOSE & CPLGS.
- C14 HOSE & CPLGS.
- POLARSEAL® HOSE & CPLGS.
- PWR. STG. HOSE & CPLGS.
- THERMO-PLASTIC HOSE & CPLGS.
- ADAPTERS
- QUICK DISCONNECT CPLGS.
- ACCESSORIES & ASSORTMENTS
- PART NUMBER INDEXES



Adapters — Metric Conversion — G63 Series

Male DIN 24° Cone – Heavy Series to Male JIC 37° Flare

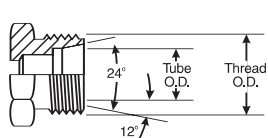

**Male 24° Cone, DIN
2353 (MDL/MDH)**

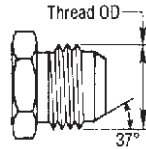

JIC 37° Male (MJ, MJLN)



| Descr | # | | |  | |
|------------|-------------|-------------|------------|---|-----------|
| | | | | MDH | MJ |
| 6MDH-4MJ | G63650-0604 | G63650-0604 | 7253-63195 | M14X1.5 | 7/16-20 |
| 8MDH-4MJ | G63650-0804 | G63650-0804 | 7253-63205 | M16X1.5 | 7/16-20 |
| 8MDH-6MJ | G63650-0806 | G63650-0806 | 7253-63215 | M16X1.5 | 9/16-18 |
| 10MDH-4MJ | 87941 | G63650-1004 | 7253-15415 | M18X1.5 | 7/16-20 |
| 10MDH-8MJ | G63650-1008 | G63650-1008 | 7253-63225 | M18X1.5 | 3/4-16 |
| 12MDH-6MJ | G63650-1206 | G63650-1206 | 7253-63235 | M20X1.5 | 9/16-18 |
| 12MDH-8MJ | G63650-1208 | G63650-1208 | 7253-63245 | M20X1.5 | 3/4-16 |
| 12MDH-10MJ | G63650-1210 | G63650-1210 | 7253-63255 | M20X1.5 | 7/8-14 |
| 14MDH-6MJ | 87942 | G63650-1406 | 7253-15425 | M22X1.5 | 9/16-18 |
| 14MDH-8MJ | G63650-1408 | G63650-1408 | 7253-63265 | M22X1.5 | 3/4-16 |
| 16MDH-8MJ | 87943 | G63650-1608 | 7253-15435 | M24X1.5 | 3/4-16 |
| 16MDH-10MJ | G63650-1610 | G63650-1610 | 7253-63285 | M24X1.5 | 7/8-12 |
| 16MDH-12MJ | G63650-1612 | G63650-1612 | 7253-63275 | M24X1.5 | 1-1/16-12 |
| 20MDH-10MJ | 87944 | G63650-2010 | 7253-15525 | M30X2.0 | 7/8-14 |
| 20MDH-12MJ | G63650-2012 | G63650-2012 | 7253-63295 | M30X2.0 | 1-1/16-12 |
| 25MDH-12MJ | 87945 | G63650-2512 | 7253-15445 | M36X2.0 | 1-1/16-12 |
| 25MDH-16MJ | G63650-2516 | G63650-2516 | 7253-63305 | M36X2.0 | 1-5/16-12 |
| 30MDH-16MJ | 87946 | G63650-3016 | 7253-15455 | M42X2.0 | 1-5/16-12 |
| 38MDH-20MJ | G63650-3820 | G63650-3820 | 7253-63315 | M52X2.0 | 1-5/8-12 |
| 38MDH-24MJ | G63650-3824 | G63650-3824 | 7253-63325 | M52X2.0 | 1-7/8-12 |

EQUIPMENT
HOSE/CPLG. SELECTION
TECH. DATA
EXT. & VERY HIGH PRESS. HOSE
GS CPLGS.
PCM CPLGS.
PCS CPLGS.
HIGH & MED. PRESS. HOSE
MEGACRIMP® CPLGS.
PC CPLGS.
FIELD ATTACHABLE CPLGS.
AIR BRAKE HOSE & CPLGS.
MEGATECH™ C5 HOSE & CPLGS.
LOW PRESS. HOSE & CPLGS.
C14 HOSE & CPLGS.
POLARSEAL® HOSE & CPLGS.
PWR. STG. HOSE & CPLGS.
THERMO-PLASTIC HOSE & CPLGS.
ADAPTERS
QUICK DISCONNECT CPLGS.
ACCESSORIES & ASSORTMENTS
PART NUMBER INDEXES



Female DIN 24° Cone Swivel – Heavy Series to Male JIC 37° Flare

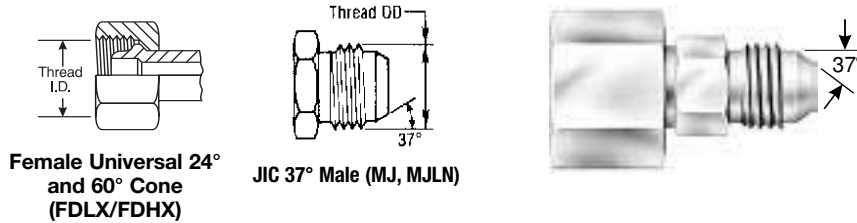

| Descr | # | | | | |
|-------------|-------------|-------------|------------|---------|-----------|
| | | FDHX | MJ | | |
| 10FDHX-4MJ | 87952 | G63750-1004 | 7253-15605 | M18X1.5 | 7/16-20 |
| 12FDHX-5MJ | 87953 | G63750-1205 | 7253-15615 | M20X1.5 | 1/2-20 |
| 12FDHX-6MJ | G63750-1206 | G63750-1206 | 7253-64845 | M20X1.5 | 9/16-18 |
| 12FDHX-8MJ | G63750-1208 | G63750-1208 | 7253-64855 | M20X1.5 | 3/4-16 |
| 12FDHX-10MJ | G63750-1210 | G63750-1210 | 7253-64865 | M20X1.5 | 7/8-14 |
| 14FDHX-6MJ | 87954 | G63750-1406 | 7253-15625 | M22X1.5 | 9/16-18 |
| 16FDHX-8MJ | 87955 | G63750-1608 | 7253-15635 | M24X1.5 | 3/4-16 |
| 20FDHX-10MJ | 87956 | G63750-2010 | 7253-15645 | M30X2.0 | 7/8-14 |
| 25FDHX-12MJ | 87957 | G63750-2512 | 7253-15655 | M36X2.0 | 1-1/16-12 |
| 30FDHX-16MJ | 87958 | G63750-3016 | 7253-15665 | M42X2.0 | 1-5/16-12 |
| 38FDHX-20MJ | 87959 | G63750-3820 | 7253-15675 | M52X2.0 | 1-5/8-12 |

Male Kobelco Plug

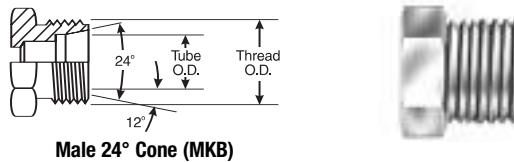

| Descr | # | |
|------------|-------------|------------|
| 22MKB-PLUG | G63980-0022 | 7253-65295 |

Male Kobelco to Male JIC 37° Flare

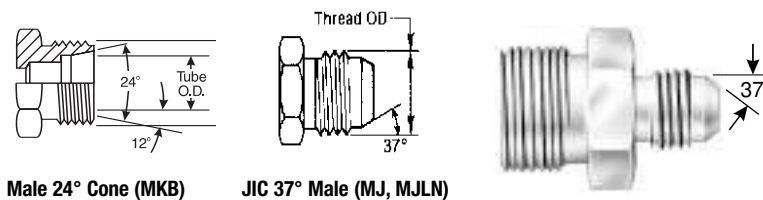

| Descr | # | | | |
|------------|-------------|------------|---------|-----------|
| | | MKB | MJ | |
| 28MKB-12MJ | G63990-2812 | 7253-65305 | M36X1.5 | 1-1/16-12 |
| 28MKB-16MJ | G63990-2816 | 7253-65315 | M36X1.5 | 1-5/16-12 |
| 35MKB-16MJ | G63990-3516 | 7253-65325 | M45X1.5 | 1-5/16-12 |
| 35MKB-20MJ | G63990-3520 | 7253-65335 | M45X1.5 | 1-5/8-12 |

EQUIPMENT

HOSE/CPLG. SELECTION

TECH. DATA

EXT. & VERY HIGH PRESS. HOSE

GS CPLGS.

PCM CPLGS.

PCS CPLGS.

HIGH & MED. PRESS. HOSE

MEGACRIMP® CPLGS.

PC CPLGS.

FIELD ATTACHABLE CPLGS.

AIR BRAKE HOSE & CPLGS.

MEGATECH® C5 HOSE & CPLGS.

LOW PRESS. HOSE & CPLGS.

C14 HOSE & CPLGS.

POLARSEAL® HOSE & CPLGS.

PWR. STG. HOSE & CPLGS.

THERMO-PLASTIC HOSE & CPLGS.

ADAPTERS

QUICK DISCONNECT CPLGS.

ACCESSORIES & ASSORTMENTS

PART NUMBER INDEXES



International to International

British Bonded Seal



| Descr | # | | ⊕ |
|--------|-------------|------------|---------|
| 2BBDS | G64075-0002 | 7253-63335 | 3/8 |
| 4BBDS | G64075-0004 | 7253-63345 | 17/32 |
| 6BBDS | G64075-0006 | 7253-63355 | 21/32 |
| 8BBDS | G64075-0008 | 7253-63365 | 13/16 |
| 10BBDS | G64075-0010 | 7253-63375 | 29/32 |
| 12BBDS | G64075-0012 | 7253-63385 | 1-1/32 |
| 16BBDS | G64075-0016 | 7253-63395 | 1-11/32 |
| 20BBDS | G64075-0020 | 7253-63405 | 1-21/32 |
| 24BBDS | G64075-0024 | 7253-63415 | 1-7/8 |
| 32BBDS | G64075-0032 | 7253-63425 | 2-11/32 |
| 40BBDS | G64075-0040 | 7253-63435 | 2-1/2 |
| 48BBDS | G64075-0048 | 7253-63445 | 3 |

Male British Standard Pipe Parallel Plug

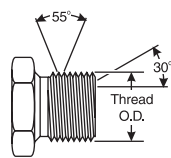

BSPT Male (MBSPT)



| Descr | # | | 🌀 |
|---------------|-------------|------------|----------|
| 2MBSPOR-PLUG | G64094-0002 | 7253-65345 | 1/8-28 |
| 4MBSPOR-PLUG | G64094-0004 | 7253-65355 | 1/4-19 |
| 6MBSPOR-PLUG | G64094-0006 | 7253-65365 | 3/8-19 |
| 8MBSPOR-PLUG | G64094-0008 | 7253-65375 | 1/2-14 |
| 12MBSPOR-PLUG | G64094-0012 | 7253-65385 | 3/4-14 |
| 16MBSPOR-PLUG | G64094-0016 | 7253-65395 | 1-11 |
| 20MBSPOR-PLUG | G64094-0020 | 7253-65405 | 1-1/4-11 |

EQUIPMENT
HOSE/CPLG. SELECTION
TECH. DATA
EXT. & VERY HIGH PRESS. HOSE
GS CPLGS.
PCM CPLGS.
PCS CPLGS.
HIGH & MED. PRESS. HOSE
MEGACRIMP® CPLGS.
PC CPLGS.
FIELD ATTACHABLE CPLGS.
AIR BRAKE HOSE & CPLGS.
MEGATECH™ C5 HOSE & CPLGS.
LOW PRESS. HOSE & CPLGS.
C14 HOSE & CPLGS.
POLARSEAL® HOSE & CPLGS.
PWR. STG. HOSE & CPLGS.
THERMO-PLASTIC HOSE & CPLGS.
ADAPTERS
QUICK DISCONNECT CPLGS.
ACCESSORIES & ASSORTMENTS
PART NUMBER INDEXES



Female British Standard Pipe Parallel Cap

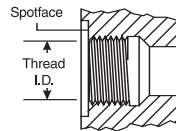

FBSP Female



| Descr | # | |  |
|------------|-------------|------------|---|
| 2FBSP-CAP | G64097-0002 | 7253-63455 | 1/8-28 |
| 4FBSP-CAP | G64097-0004 | 7253-63465 | 1/4-19 |
| 6FBSP-CAP | G64097-0006 | 7253-63475 | 3/8-19 |
| 8FBSP-CAP | G64097-0008 | 7253-63485 | 1/2-14 |
| 10FBSP-CAP | G64097-0010 | 7253-63495 | 5/8-14 |
| 12FBSP-CAP | G64097-0012 | 7253-63505 | 3/4-14 |
| 16FBSP-CAP | G64097-0016 | 7253-63515 | 1-11 |
| 20FBSP-CAP | G64097-0020 | 7253-63525 | 1-1/4-11 |
| 24FBSP-CAP | G64097-0024 | 7253-63535 | 1-1/2-11 |
| 32FBSP-CAP | G64097-0032 | 7253-63545 | 2-11 |

Male British Standard Pipe Tapered Thread Plug

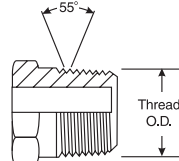

BSPT Male (MBSPT)



| Descr | # | |  |
|--------------|-------------|------------|---|
| 2MBSPT-PLUG | G64098-0002 | 7253-63555 | 1/8-28 |
| 4MBSPT-PLUG | G64098-0004 | 7253-63565 | 1/4-19 |
| 6MBSPT-PLUG | G64098-0006 | 7253-63575 | 3/8-19 |
| 8MBSPT-PLUG | G64098-0008 | 7253-63585 | 1/2-14 |
| 10MBSPT-PLUG | G64098-0010 | 7253-63595 | 5/8-14 |
| 12MBSPT-PLUG | G64098-0012 | 7253-63605 | 3/4-14 |
| 16MBSPT-PLUG | G64098-0016 | 7253-63615 | 1-11 |
| 20MBSPT-PLUG | G64098-0020 | 7253-63625 | 1-1/4-11 |
| 24MBSPT-PLUG | G64098-0024 | 7253-63635 | 1-1/2-11 |
| 32MBSPT-PLUG | G64098-0032 | 7253-63645 | 2-11 |

Male British Standard Pipe Parallel Plug

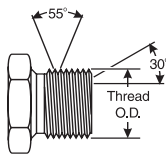

BSPT Male (MBSPT)



| Descr | # | |  |
|--------------|-------------|------------|---|
| 2MBSPP-PLUG | G64099-0002 | 7253-63655 | 1/8-28 |
| 4MBSPP-PLUG | G64099-0004 | 7253-63665 | 1/4-19 |
| 6MBSPP-PLUG | G64099-0006 | 7253-63675 | 3/8-19 |
| 8MBSPP-PLUG | G64099-0008 | 7253-63685 | 1/2-14 |
| 10MBSPP-PLUG | G64099-0010 | 7253-63695 | 5/8-14 |
| 12MBSPP-PLUG | G64099-0012 | 7253-63705 | 3/4-14 |
| 16MBSPP-PLUG | G64099-0016 | 7253-63715 | 1-11 |
| 20MBSPP-PLUG | G64099-0020 | 7253-63725 | 1-1/4-11 |
| 24MBSPP-PLUG | G64099-0024 | 7253-63735 | 1-1/2-11 |
| 32MBSPP-PLUG | G64099-0032 | 7253-63745 | 2-11 |

EQUIPMENT

HOSE/CPLG. SELECTION

TECH. DATA

EXT. & VERY HIGH PRESS. HOSE

GS CPLGS.

PCM CPLGS.

PCS CPLGS.

HIGH & MED. PRESS. HOSE

MEGACRIMP® CPLGS.

PC CPLGS.

FIELD ATTACHABLE CPLGS.

AIR BRAKE HOSE & CPLGS.

MEGATECH® C5 HOSE & CPLGS.

LOW PRESS. HOSE & CPLGS.

C14 HOSE & CPLGS.

POLARSEAL® HOSE & CPLGS.

PWR. STG. HOSE & CPLGS.

THERMO-PLASTIC HOSE & CPLGS.

ADAPTERS

QUICK DISCONNECT CPLGS.

ACCESSORIES & ASSORTMENTS

PART NUMBER INDEXES



Male British Standard Pipe Parallel to Female British Standard Pipe Parallel Swivel

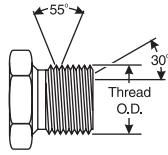

BSPP Male (MBSPP)

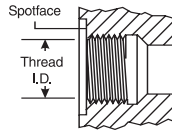

FBSPP Female



| DESCR | # | | |  | |
|------------------|-------------|-------------|------------|---|----------|
| | | | | MBSPP | FBSPPX |
| 2MBSPP-2FBSPPX | G64350-0202 | G64350-0202 | 7253-63775 | 1/8-28 | 1/8-28 |
| 2MBSPP-4FBSPPX | G64350-0204 | G64350-0204 | 7253-63785 | 1/8-28 | 1/4-19 |
| 4MBSPP-2FBSPPX | G64350-0402 | G64350-0402 | 7253-63795 | 1/4-19 | 1/8-28 |
| 4MBSPP-4FBSPPX | 87917 | G64350-0404 | 7253-15185 | 1/4-19 | 1/4-19 |
| 4MBSPP-6FBSPPX | G64350-0406 | G64350-0406 | 7253-63805 | 1/4-19 | 3/8-19 |
| 4MBSPP-8FBSPPX | G64350-0408 | G64350-0408 | 7253-63815 | 1/4-19 | 1/2-14 |
| 6MBSPP-4FBSPPX | G64350-0604 | G64350-0604 | 7253-63825 | 3/8-19 | 1/4-19 |
| 6MBSPP-6FBSPPX | 87918 | G64350-0606 | 7253-15195 | 3/8-19 | 3/8-19 |
| 6MBSPP-8FBSPPX | G64350-0608 | G64350-0608 | 7253-63835 | 3/8-19 | 1/2-14 |
| 8MBSPP-6FBSPPX | G64350-0806 | G64350-0806 | 7253-63845 | 1/2-14 | 3/8-19 |
| 8MBSPP-8FBSPPX | 87919 | G64350-0808 | 7253-15205 | 1/2-14 | 1/2-14 |
| 8MBSPP-10FBSPPX | G64350-0810 | G64350-0810 | 7253-63855 | 1/2-14 | 5/8-14 |
| 8MBSPP-12FBSPPX | G64350-0812 | G64350-0812 | 7253-63865 | 1/2-14 | 3/4-14 |
| 10MBSPP-8FBSPPX | G64350-1008 | G64350-1008 | 7253-63875 | 5/8-14 | 1/2-14 |
| 10MBSPP-10FBSPPX | 87920 | G64350-1010 | 7253-15215 | 5/8-14 | 5/8-14 |
| 10MBSPP-12FBSPPX | G64350-1012 | G64350-1012 | 7253-63885 | 5/8-14 | 3/4-14 |
| 12MBSPP-6FBSPPX | G64350-1206 | G64350-1206 | 7253-63895 | 3/4-14 | 3/8-19 |
| 12MBSPP-8FBSPPX | G64350-1208 | G64350-1208 | 7253-63905 | 3/4-14 | 1/2-14 |
| 12MBSPP-10FBSPPX | G64350-1210 | G64350-1210 | 7253-63915 | 3/4-14 | 5/8-14 |
| 12MBSPP-12FBSPPX | 87921 | G64350-1212 | 7253-15225 | 3/4-14 | 3/4-14 |
| 12MBSPP-16FBSPPX | G64350-1216 | G64350-1216 | 7253-63925 | 3/4-14 | 1-11 |
| 12MBSPP-20FBSPPX | G64350-1220 | G64350-1220 | 7253-63935 | 3/4-14 | 1-1/4-11 |
| 16MBSPP-12FBSPPX | G64350-1612 | G64350-1612 | 7253-63945 | 1-11 | 3/4-14 |
| 16MBSPP-16FBSPPX | 87922 | G64350-1616 | 7253-15235 | 1-11 | 1-11 |
| 16MBSPP-20FBSPPX | G64350-1620 | G64350-1620 | 7253-63955 | 1-11 | 1-1/4-11 |
| 20MBSPP-16FBSPPX | G64350-2016 | G64350-2016 | 7253-63965 | 1-1/4-11 | 1-11 |
| 20MBSPP-20FBSPPX | G64350-2020 | G64350-2020 | 7253-63975 | 1-1/4-11 | 1-1/4-11 |
| 20MBSPP-24FBSPPX | G64350-2024 | G64350-2024 | 7253-63985 | 1-1/4-11 | 1-1/2-11 |
| 24MBSPP-20FBSPPX | G64350-2420 | G64350-2420 | 7253-63995 | 1-1/2-11 | 1-1/4-11 |
| 24MBSPP-24FBSPPX | G64350-2424 | G64350-2424 | 7253-64005 | 1-1/2-11 | 1-1/2-11 |
| 32MBSPP-32FBSPPX | G64350-3232 | G64350-3232 | 7253-64015 | 2-11 | 2-11 |

EQUIPMENT
HOSE/CPLG. SELECTION
TECH. DATA
EXT. & VERY HIGH PRESS. HOSE
GS CPLGS.
PCM CPLGS.
PCS CPLGS.
HIGH & MED. PRESS. HOSE
MEGACRIMP® CPLGS.
PC CPLGS.
FIELD ATTACHABLE CPLGS.
AIR BRAKE HOSE & CPLGS.
MEGATECH®/C5 HOSE & CPLGS.
LOW PRESS. HOSE & CPLGS.
C14 HOSE & CPLGS.
POLARSEAL® HOSE & CPLGS.
PWR. STG. HOSE & CPLGS.
THERMO-PLASTIC HOSE & CPLGS.
ADAPTERS
QUICK DISCONNECT CPLGS.
ACCESSORIES & ASSORTMENTS
PART NUMBER INDEXES

FIELD



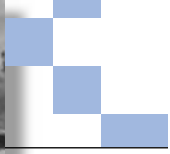

Metric Bonded Seal



| Descr | # | |  |
|--------|-------------|------------|---|
| 6MBDS | G64775-0006 | 7253-64025 | 6 |
| 8MBDS | G64775-0008 | 7253-64035 | 8 |
| 10MBDS | G64775-0010 | 7253-64045 | 10 |
| 12MBDS | G64775-0012 | 7253-64055 | 12 |
| 14MBDS | G64775-0014 | 7253-64065 | 14 |
| 16MBDS | G64775-0016 | 7253-64075 | 16 |
| 18MBDS | G64775-0018 | 7253-64085 | 18 |
| 20MBDS | G64775-0020 | 7253-64095 | 20 |
| 22MBDS | G64775-0022 | 7253-64105 | 22 |
| 24MBDS | G64775-0024 | 7253-64115 | 24 |
| 26MBDS | G64775-0026 | 7253-64125 | 26 |
| 27MBDS | G64775-0027 | 7253-64135 | 27 |
| 30MBDS | G64775-0030 | 7253-64145 | 30 |
| 33MBDS | G64775-0033 | 7253-64155 | 33 |
| 36MBDS | G64775-0036 | 7253-64165 | 36 |
| 42MBDS | G64775-0042 | 7253-64175 | 42 |
| 45MBDS | G64775-0045 | 7253-64185 | 45 |
| 50MBDS | G64775-0050 | 7253-64195 | 50 |
| 52MBDS | G64775-0052 | 7253-64205 | 52 |

Male Metric Plug



| Descr | # | |  |
|-----------|-------------|------------|---|
| 8MM-PLUG | G64790-0008 | 7253-64215 | M08X1.0 |
| 10MM-PLUG | G64790-0010 | 7253-64225 | M10X1.5 |
| 12MM-PLUG | G64790-0012 | 7253-64235 | M12X1.5 |
| 14MM-PLUG | G64790-0014 | 7253-64245 | M14X1.5 |
| 16MM-PLUG | G64790-0016 | 7253-64255 | M16X1.5 |
| 18MM-PLUG | G64790-0018 | 7253-64265 | M18X1.5 |
| 20MM-PLUG | G64790-0020 | 7253-64275 | M20X1.5 |
| 22MM-PLUG | G64790-0022 | 7253-64285 | M22X1.5 |
| 24MM-PLUG | G64790-0024 | 7253-64295 | M24X1.5 |
| 26MM-PLUG | G64790-0026 | 7253-64305 | M26X1.5 |
| 30MM-PLUG | G64790-0030 | 7253-64315 | M30X1.5 |

EQUIPMENT

HOSE/CPLG.
SELECTION

TECH. DATA

EXT. &
VERY HIGH
PRESS. HOSE

GS CPLGS.

PCM CPLGS.

PCS CPLGS.

HIGH & MED.
PRESS. HOSEMEGACRIMP®
CPLGS.

PC CPLGS.

FIELD
ATTACHABLE
CPLGS.AIR BRAKE
HOSE &
CPLGS.MEGATECH®
C5
HOSE &
CPLGS.LOW PRESS.
HOSE &
CPLGS.C14 HOSE
& CPLGS.POLARSEAL®
HOSE &
CPLGS.PWR. STG.
HOSE &
CPLGS.THERMO-
PLASTIC
HOSE &
CPLGS.

ADAPTERS

QUICK
DISCONNECT
CPLGS.ACCESSORIES
& ASSORT-
MENTSPART NUMBER
INDEXES

Adapters — International to International – G64 Series

Male DIN 24° Cone – Light Series Plug

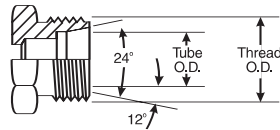

Male 24° Cone, DIN 2353



| Descr | # | |  |
|------------|-------------|------------|---|
| 6MDL-PLUG | G64792-0006 | 7253-64325 | M12X1.5 |
| 8MDL-PLUG | G64792-0008 | 7253-64335 | M14X1.5 |
| 10MDL-PLUG | G64792-0010 | 7253-64345 | M16X1.5 |
| 12MDL-PLUG | G64792-0012 | 7253-64355 | M18X1.5 |
| 15MDL-PLUG | G64792-0015 | 7253-64365 | M22X1.5 |
| 18MDL-PLUG | G64792-0018 | 7253-64375 | M26X1.5 |
| 22MDL-PLUG | G64792-0022 | 7253-64385 | M30X2.0 |
| 28MDL-PLUG | G64792-0028 | 7253-64395 | M36X2.0 |
| 35MDL-PLUG | G64792-0035 | 7253-64405 | M45X2.0 |
| 42MDL-PLUG | G64792-0042 | 7253-64415 | M52X2.0 |

Female DIN 24° Cone – Light Series Cap

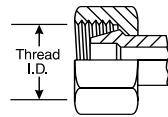

Female 24° Cone



| Descr | # | |  |
|-----------|-------------|------------|---|
| 6FDL-CAP | G64793-0006 | 7253-64425 | M12X1.5 |
| 8FDL-CAP | G64793-0008 | 7253-64435 | M14X1.5 |
| 10FDL-CAP | G64793-0010 | 7253-64445 | M16X1.5 |
| 12FDL-CAP | G64793-0012 | 7253-64455 | M18X1.5 |
| 15FDL-CAP | G64793-0015 | 7253-64465 | M22X1.5 |
| 18FDL-CAP | G64793-0018 | 7253-64475 | M26X1.5 |
| 22FDL-CAP | G64793-0022 | 7253-64485 | M30X2.0 |
| 28FDL-CAP | G64793-0028 | 7253-64495 | M36X2.0 |
| 35FDL-CAP | G64793-0035 | 7253-64505 | M45X2.0 |
| 42FDL-CAP | G64793-0042 | 7253-64515 | M52X2.0 |

EQUIPMENT

HOSE/CPLG.
SELECTION

TECH. DATA

EXT. &
VERY HIGH
PRESS. HOSE

GS CPLGS.

PCM CPLGS.

PCS CPLGS.

HIGH & MED.
PRESS. HOSE

MEGACRIMP®
CPLGS.

PC CPLGS.

FIELD
ATTACHABLE
CPLGS.

AIR BRAKE
HOSE &
CPLGS.

MEGATECH™/
C5
HOSE &
CPLGS.

LOW PRESS.
HOSE &
CPLGS.

C14 HOSE
& CPLGS.

POLARSEAL®
HOSE &
CPLGS.

PWR. STG.
HOSE &
CPLGS.

THERMO-
PLASTIC
HOSE &
CPLGS.

ADAPTERS

QUICK
DISCONNECT
CPLGS.

ACCESSORIES
& ASSORT-
MENTS

PART NUMBER
INDEXES



Male DIN 24° Cone – Heavy Series Plug

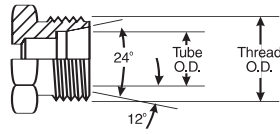

Male 24° Cone, DIN 2353



| Descr | # | |  |
|------------|-------------|------------|---|
| 8MDH-PLUG | G64794-0008 | 7253-64535 | M16X1.5 |
| 10MDH-PLUG | G64794-0010 | 7253-64545 | M18X1.5 |
| 12MDH-PLUG | G64794-0012 | 7253-64555 | M20X1.5 |
| 14MDH-PLUG | G64794-0014 | 7253-64565 | M22X1.5 |
| 16MDH-PLUG | G64794-0016 | 7253-64575 | M24X1.5 |
| 20MDH-PLUG | G64794-0020 | 7253-64585 | M30X2.0 |
| 25MDH-PLUG | G64794-0025 | 7253-64595 | M36X2.0 |
| 30MDH-PLUG | G64794-0030 | 7253-64605 | M42X2.0 |
| 38MDH-PLUG | G64794-0038 | 7253-64615 | M52X2.0 |

Female DIN 24° Cone – Heavy Series Cap

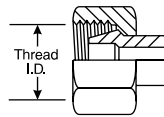

Female 24° Cone



| Descr | # | |  |
|-----------|-------------|------------|---|
| 8FDH-CAP | G64795-0008 | 7253-64635 | M16X1.5 |
| 10FDH-CAP | G64795-0010 | 7253-64645 | M18X1.5 |
| 12FDH-CAP | G64795-0012 | 7253-64655 | M20X1.5 |
| 14FDH-CAP | G64795-0014 | 7253-64665 | M22X1.5 |
| 16FDH-CAP | G64795-0016 | 7253-64675 | M24X1.5 |
| 20FDH-CAP | G64795-0020 | 7253-64685 | M30X2.0 |
| 25FDH-CAP | G64795-0025 | 7253-64695 | M36X2.0 |
| 30FDH-CAP | G64795-0030 | 7253-64705 | M42X2.0 |
| 38FDH-CAP | G64795-0038 | 7253-64715 | M52X2.0 |

EQUIPMENT

HOSE/CPLG. SELECTION

TECH. DATA

EXT. & VERY HIGH PRESS. HOSE

GS CPLGS.

PCM CPLGS.

PCS CPLGS.

HIGH & MED. PRESS. HOSE

MEGACRIMP® CPLGS.

PC CPLGS.

FIELD ATTACHABLE CPLGS.

AIR BRAKE HOSE & CPLGS.

MEGATECH® C5 HOSE & CPLGS.

LOW PRESS. HOSE & CPLGS.

C14 HOSE & CPLGS.

POLARSEAL® HOSE & CPLGS.

PWR. STG. HOSE & CPLGS.

THERMO-PLASTIC HOSE & CPLGS.

ADAPTERS

QUICK DISCONNECT CPLGS.

ACCESSORIES & ASSORTMENTS

PART NUMBER INDEXES



Adapters — Japanese Conversion — G65 Series

Japanese Conversion

Female Japanese Industrial Standard Cap

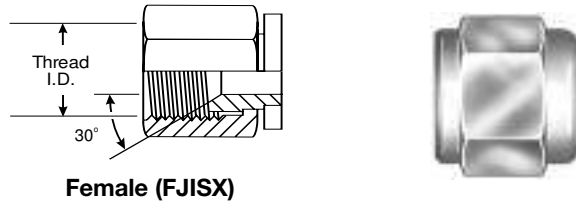

Female (FJISX)

| Descr | # | |  |
|------------|-------------|------------|---|
| 4FJIS-CAP | G65097-0004 | 7253-64875 | 1/4-19 |
| 6FJIS-CAP | G65097-0006 | 7253-64885 | 3/8-19 |
| 8FJIS-CAP | G65097-0008 | 7253-64895 | 1/2-14 |
| 12FJIS-CAP | G65097-0012 | 7253-64905 | 3/4-14 |
| 16FJIS-CAP | G65097-0016 | 7253-64915 | 1-11 |
| 20FJIS-CAP | G65097-0020 | 7253-64925 | 1-1/4-11 |
| 24FJIS-CAP | G65097-0024 | 7253-64935 | 1-1/2-11 |
| 32FJIS-CAP | G65097-0032 | 7253-64945 | 2-11 |

Male Japanese Industrial Standard Plug

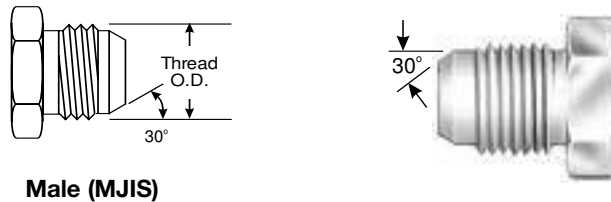

Male (MJIS)

| Descr | # | |  |
|-------------|-------------|------------|---|
| 4MJIS-PLUG | G65099-0004 | 7253-64955 | 1/4-19 |
| 6MJIS-PLUG | G65099-0006 | 7253-64965 | 3/8-19 |
| 8MJIS-PLUG | G65099-0008 | 7253-64975 | 1/2-14 |
| 12MJIS-PLUG | G65099-0012 | 7253-64985 | 3/4-14 |
| 6MJIS-PLUG | G65099-0016 | 7253-64995 | 1-11 |
| 20MJIS-PLUG | G65099-0020 | 7253-65005 | 1-1/4-11 |
| 24MJIS-PLUG | G65099-0024 | 7253-65015 | 1-1/2-11 |
| 32MJIS-PLUG | G65099-0032 | 7253-65025 | 2-11 |

EQUIPMENT
HOSE/CPLG. SELECTION
TECH. DATA
EXT. & VERY HIGH PRESS. HOSE
GS CPLGS.
PCM CPLGS.
PCS CPLGS.
HIGH & MED. PRESS. HOSE
MEGACRIMP® CPLGS.
PC CPLGS.
FIELD ATTACHABLE CPLGS.
AIR BRAKE HOSE & CPLGS.
MEGATECH™/C5 HOSE & CPLGS.
LOW PRESS. HOSE & CPLGS.
C14 HOSE & CPLGS.
POLARSEAL® HOSE & CPLGS.
PWR. STG. HOSE & CPLGS.
THERMO-PLASTIC HOSE & CPLGS.
ADAPTERS
QUICK DISCONNECT CPLGS.
ACCESSORIES & ASSORTMENTS
PART NUMBER INDEXES



Female Japanese Industrial Standard to Male JIC 37° Flare

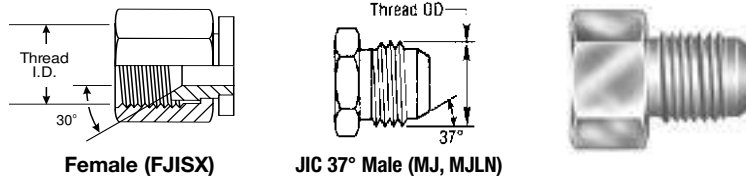

Female (FJISX)

JIC 37° Male (MJ, MJLN)

| Descr | # | |  | |
|-------------|-------------|------------|---|-----------|
| | | | FJIS | MJ |
| 4FJIS-4MJ | G65100-0404 | 7253-65035 | 1/4-19 | 7/16-20 |
| 6FJIS-4MJ | G65100-0604 | 7253-65045 | 3/8-19 | 7/16-20 |
| 6FJIS-6MJ | G65100-0606 | 7253-65055 | 3/8-19 | 9/16-18 |
| 6FJIS-8MJ | G65100-0608 | 7253-65065 | 3/8-19 | 3/4-16 |
| 8FJIS-8MJ | G65100-0808 | 7253-65075 | 1/2-14 | 3/4-16 |
| 12FJIS-12MJ | G65100-1212 | 7253-65085 | 3/4-14 | 1-1/16-12 |
| 16FJIS-16MJ | G65100-1616 | 7253-65095 | 1-11 | 1-5/16-12 |
| 20FJIS-20MJ | G65100-2020 | 7253-65105 | 1-1/4-11 | 1-5/8-12 |

Female Komatsu Cap

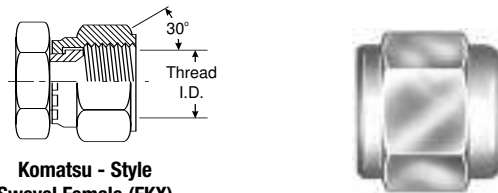

Komatsu - Style
Swevel Female (FKX)

| Descr | # | |  |
|----------|-------------|------------|---|
| 4FK-CAP | G65597-0004 | 7253-65115 | M14X1.5 |
| 6FK-CAP | G65597-0006 | 7253-65125 | M18X1.5 |
| 8FK-CAP | G65597-0008 | 7253-65135 | M22X1.5 |
| 10FK-CAP | G65597-0010 | 7253-65145 | M24X1.5 |
| 12FK-CAP | G65597-0012 | 7253-65155 | M30X1.5 |
| 16FK-CAP | G65597-0016 | 7253-65165 | M33X1.5 |

Male Komatsu Plug

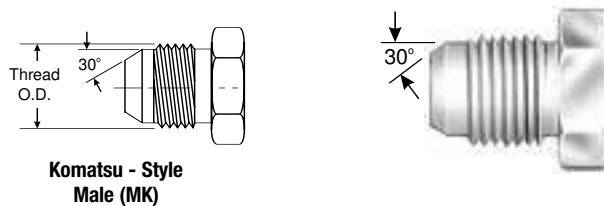

Komatsu - Style
Male (MK)

| Descr | # | |  |
|-----------|-------------|------------|---|
| 4MK-PLUG | G65599-0004 | 7253-65175 | M14X1.5 |
| 6MK-PLUG | G65599-0006 | 7253-65185 | M18X1.5 |
| 8MK-PLUG | G65599-0008 | 7253-65195 | M22X1.5 |
| 10MK-PLUG | G65599-0010 | 7253-65205 | M24X1.5 |
| 12MK-PLUG | G65599-0012 | 7253-65215 | M30X1.5 |
| 16MK-PLUG | G65599-0016 | 7253-65225 | M33X1.5 |

| |
|------------------------------|
| EQUIPMENT |
| HOSE/CPLG. SELECTION |
| TECH. DATA |
| EXT. & VERY HIGH PRESS. HOSE |
| GS CPLGS. |
| PCM CPLGS. |
| PCS CPLGS. |
| HIGH & MED. PRESS. HOSE |
| MEGACRIMP® CPLGS. |
| PC CPLGS. |
| FIELD ATTACHABLE CPLGS. |
| AIR BRAKE HOSE & CPLGS. |
| MEGATECH® C5 HOSE & CPLGS. |
| LOW PRESS. HOSE & CPLGS. |
| C14 HOSE & CPLGS. |
| POLARSEAL® HOSE & CPLGS. |
| PWR. STG. HOSE & CPLGS. |
| THERMO-PLASTIC HOSE & CPLGS. |
| ADAPTORS |
| QUICK DISCONNECT CPLGS. |
| ACCESSORIES & ASSORTMENTS |
| PART NUMBER INDEXES |



Adapters — Japanese Conversion — G65 Series

Female Komatsu to Male JIC 37° Flare

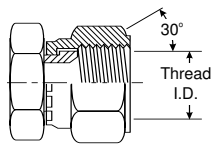

**Komatsu - Style
Swevel Female (FKX)**

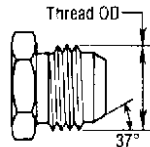

JIC 37° Male (MJ, MJLN)



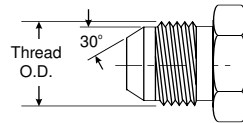

| Descr | # | |  | |
|-----------|-------------|------------|---|-----------|
| | | | FK | MJ |
| 4FK-4MJ | G65600-0404 | 7253-65235 | M14X1.5 | 7/16-20 |
| 6FK-6MJ | G65600-0606 | 7253-65245 | M18X1.5 | 9/16-18 |
| 8FK-8MJ | G65600-0808 | 7253-65255 | M22X1.5 | 3/4-16 |
| 10FK-10MJ | G65600-1010 | 7253-65265 | M24X1.5 | 7/8-14 |
| 12FK-12MJ | G65600-1212 | 7253-65275 | M30X1.5 | 1-1/16-12 |
| 16FK-16MJ | G65600-1616 | 7253-65285 | M33X1.5 | 1-5/16-12 |

Male Komatsu to Male Komatsu

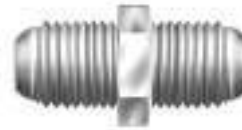

**Komatsu - Style
Male (MK)**



| Descr | # | |  | |
|-----------|-------------|------------|---|----|
| | | | MK | MJ |
| 4MK-4MK | G65700-0404 | 7253-65765 | M14X1.5 | |
| 6MK-6MK | G65700-0606 | 7253-65775 | M18X1.5 | |
| 8MK-8MK | G65700-0808 | 7253-65785 | M22X1.5 | |
| 10MK-10MK | G65700-1010 | 7253-65795 | M24X1.5 | |
| 12MK-12MK | G65700-1212 | 7253-65805 | M30X1.5 | |
| 16MK-16MK | G65700-1616 | 7253-65815 | M33X1.5 | |

Male Komatsu to Male JIC 37° Flare

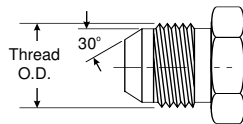

**Komatsu - Style
Male (MK)**

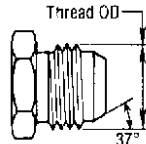

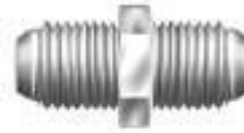

JIC 37° Male (MJ, MJLN)

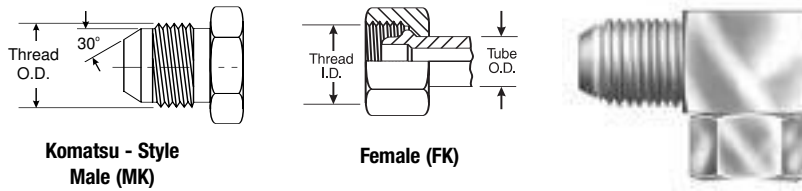

| Descr | # | |  | |
|-----------|-------------|------------|---|-----------|
| | | | MK | MJ |
| 4MK-4MJ | G65750-0404 | 7253-65825 | M14X1.5 | 1/2-20 |
| 6MK-6MJ | G65750-0606 | 7253-65835 | M18X1.5 | 9/16-18 |
| 8MK-8MJ | G65750-0808 | 7253-65845 | M22X1.5 | 3/4-16 |
| 10MK-10MJ | G65750-1010 | 7253-65855 | M24X1.5 | 7/8-14 |
| 12MK-12MJ | G65750-1212 | 7253-65865 | M30X1.5 | 1-1/16-12 |
| 16MK-16MJ | G65750-1616 | 7253-65875 | M33X1.5 | 1-5/16-12 |

Male Komatsu to Female Komatsu – 90°



| Descr | # | |  | |
|-------------|-------------|------------|---|---------|
| | | | MK | FK |
| 4MK-4FK90 | G65800-0404 | 7253-65945 | M14X1.5 | M14X1.5 |
| 6MK-6FK90 | G65800-0606 | 7253-65965 | M18X1.5 | M18X1.5 |
| 8MK-8FK90 | G65800-0808 | 7253-65975 | M22X1.5 | M22X1.5 |
| 10MK-10FK90 | G65800-1010 | 7253-65985 | M24X1.5 | M24X1.5 |
| 12MK-12FK90 | G65800-1212 | 7253-65995 | M30X1.5 | M30X1.5 |
| 16MK-16FK90 | G65800-1616 | 7253-66005 | M33X1.5 | M33X1.5 |

Male Komatsu to Female Komatsu to Male Komatsu – Tee

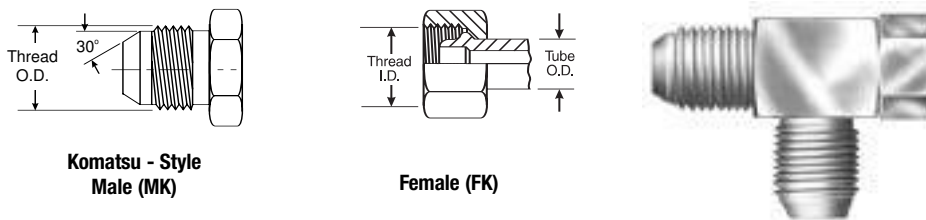

| Descr | # | |  | |
|----------------|-------------|------------|---|---------|
| | | | MK | FK |
| 4MK-4FK-4MK | G65950-0404 | 7253-65885 | M14X1.5 | M14X1.5 |
| 6MK-6FK-6MK | G65950-0606 | 7253-65905 | M18X1.5 | M18X1.5 |
| 8MK-8FK-8MK | G65950-0808 | 7253-65915 | M22X1.5 | M22X1.5 |
| 10MK-10FK-10MK | G65950-1010 | 7253-65925 | M24X1.5 | M24X1.5 |
| 12MK-12FK-12MK | G65950-1212 | 7253-65935 | M30X1.5 | M30X1.5 |

| |
|------------------------------|
| EQUIPMENT |
| HOSE/CPLG. SELECTION |
| TECH. DATA |
| EXT. & VERY HIGH PRESS. HOSE |
| GS CPLGS. |
| PCM CPLGS. |
| PCS CPLGS. |
| HIGH & MED. PRESS. HOSE |
| MEGACRIMP® CPLGS. |
| PC CPLGS. |
| FIELD ATTACHABLE CPLGS. |
| AIR BRAKE HOSE & CPLGS. |
| MEGATECH® C5 HOSE & CPLGS. |
| LOW PRESS. HOSE & CPLGS. |
| C14 HOSE & CPLGS. |
| POLARSEAL® HOSE & CPLGS. |
| PWR. STG. HOSE & CPLGS. |
| THERMO-PLASTIC HOSE & CPLGS. |
| ADAPTERS |
| QUICK DISCONNECT CPLGS. |
| ACCESSORIES & ASSORTMENTS |
| PART NUMBER INDEXES |

